

National Aviation University
Ministry of Science and Education of Ukraine

Qualifying scientific work on
the rights of the manuscript

OKORO ONYEDIKACHI CHIOMA

UDC 629.735.083.02/.06:629.735.07(669.1)(043.5)

DISSERTATION

**OPTIMIZATION OF AIRCRAFT MAINTENANCE PROCESSES FOR
CONTINUING AIRWORTHINESS IN NIGERIA**

272 – Aviation Transport

A dissertation submitted in fulfillment of the requirements for the degree of Doctor of Philosophy

The dissertation contains the results of my research. The use of ideas, results, and texts of other authors have references to the appropriate sources



Okoro O.C.

Scientific Advisor: Dmytriiev Serhii, Doctor of Sciences (Engineering), Professor

Kyiv–2023

ABSTRACT

Okoro O.C. Optimization of aircraft maintenance processes for continuing airworthiness in Nigeria. – Qualifying scientific work on the rights of the manuscript.

Dissertation for obtaining a scientific degree of Doctor of Philosophy for the specialty 272 – Aviation transport, specialization – Operation and Maintenance of Aircraft – National Aviation University, Ministry of Education and Science of Ukraine, Kyiv, 2023.

This dissertation addresses the critical scientific problem of optimization of aircraft maintenance processes for cost-effective and efficient aircraft operations without compromising safety.

This research includes the analysis of existing studies related to the optimization of aircraft maintenance processes and their potential for minimizing maintenance cost, which currently covers 10-20% (up to 30% in some regions) of aircraft operational costs. The analysis highlighted the gap in models and algorithms based on reliability theory, machine learning, regression, and probability and statistics theories for optimizing aircraft maintenance in the first three phases of the aircraft lifecycle.

Another focus of this research is the provision of a simple and expandable framework for maximizing the utilization of daily aircraft operations data, which is often stored but primarily disregarded. Its' approach is expected to reduce waste that arises because of early maintenance and failure costs connected with late maintenance actions.

The *introduction* justifies the relevance of the dissertation, formulates the purpose and main objectives of the study, and provides information on the research's relationship with scientific programs and topics. In addition, the scientific novelty and practical significance of the study are highlighted, the applicant's contribution in joint publications is noted, the

approbation of the results of the dissertation work are outlined, structure and volume of the dissertation are given.

The *first chapter* gives an overview of aircraft maintenance in Nigeria, an in-depth analysis of existing aircraft maintenance optimization models, and a simple numerical reliability analysis of aircraft operating in Nigeria.

Various aircraft types are in operation in Nigeria, and the commercial helicopter sector contributes to the economy by providing search and rescue services, and transportation to the offshore oil and gas industry. The NCAA is the only aviation regulatory authority in Nigeria; Part 5 of the NigCARs presents regulatory requirements for the continuing airworthiness of aircraft expected to operate in Nigeria in line with the SARPs in ICAO Annexes 6 and 8. ICAO Part M represents a compulsory operating license for aircraft operators and contains the minimum requirements for maintenance and airworthiness. The MRBR forms the basis for the maintenance program, which is part of the approved maintenance system and must be monitored by qualified engineers for suitability at least annually. Operators in Nigeria typically follow either the MSG-2 or MSG-3 philosophy of aircraft maintenance.

To optimize aircraft maintenance, many researchers have suggested and tested a range of techniques based on aspects of aircraft maintenance processes such as planning, scheduling, maintenance task allocation, aircraft maintenance routing, spare parts inventory, personnel, and skill management, use of aircraft prognostics and health management data, and reliability models. However, insufficient attention is being paid to the development of models that consolidate the use of reliability theory models, machine learning, predictive analytics, regression models, and probability and statistics theories for optimizing aircraft maintenance. These industry 4.0 concepts form a framework for data-driven predictive aircraft maintenance, which will be the basis for carrying out aircraft maintenance tasks in the near future.

To begin the development of these models, a simple numerical reliability analysis using daily aircraft operations data was carried out. This highlighted the least reliable aircraft systems

or structures for each fleet analyzed alongside the dynamics of the failure rate of each aircraft fleet.

The *second chapter* is devoted to developing aircraft maintenance optimization models and algorithms using principles of reliability theory, predictive analytics, regression, machine learning, probability, and statistics theory.

The models developed for reliability analysis of aircraft components, subsystems, systems, and structures determine the characteristic reliability of aircraft systems for optimizing aircraft maintenance. They can be applied to improve existing reliability-centered maintenance frameworks irrespective of the dataset's size. Furthermore, segmented regression models were developed to predict the occurrence of faults/failures.

As aircraft components and systems deteriorate, it is crucial to carry out maintenance actions, which increases operational costs. Therefore, there is a need for an optimal interval that balances the frequency of aircraft maintenance tasks and the failure rate. In this section, models were developed to determine an optimal aircraft maintenance task interval. In addition, this model quantifies the cost and benefits of maintenance to obtain an optimum balance between both.

Forecasting spare parts demand can be a challenging exercise because demand is stochastic. However, a good knowledge of the failure trend and distribution can provide optimal solutions. In this study, models that can create efficient spare parts inventory management to provide adequate services for maintenance needs were developed. The proposed models focus on the interaction between failure rates and spare parts inventory.

In the *third chapter*, the models developed in the second chapter were validated using daily aircraft operations data from Nigeria. The χ^2 goodness-of-fit test was applied to mathematical models for reliability analysis (for dataset > 35) to verify if it obeys the exponential distribution. The calculated χ^2 is less than the threshold value χ_{th}^2 ; hence the hypothesis for the exponential distribution law of mean time between failures of aircraft systems

and structures is accepted with a significance level equal to 0.05. For the proposed model for reliability analysis given a small dataset, a visual goodness-of-fit test that proves its validity is carried out.

To determine which of the segmented regression models proposed gives the most prediction accuracy, all models were tested using real-life aircraft operational data. The model with the least value of standard deviation σ is considered the most precise for predicting the failure of an aircraft component, subsystem, system, or structure. Furthermore, a pictorial representation of good, over- and underfitting in regression was used to compare all the resulting graphs of the proposed regression models; all the models were in accordance with good fitting.

Simulation analysis was carried out using the Monte Carlo method to prove the applicability of the models developed for determining the optimal maintenance task interval using average operational cost as a measure of efficiency. Results demonstrate that for the exponential model of time between failures, an optimal maintenance task interval that corresponds to a local minimum point on the graph of average operational cost per unit time vs maintenance task interval T_M does not exist; $T_{Mopt} \rightarrow \infty$. For the Erlang model, simulation results prove the existence of a “minimum” which corresponds to an optimal maintenance task interval. These results coincide with the analytical results in Chapter 2 and further prove that optimizing the maintenance task interval of aircraft systems using the Erlang model is possible.

For the spare parts forecast models, the aircraft components are considered non-repairable items and have exponentially distributed times to failure. The quantity of spare parts is calculated using the required probability of failure-free operation and the estimated failure rate value obtained from real statistical data analysis. To analyse the accuracy of the proposed model, a simulation based on the Monte Carlo method was performed, and the results favourably coincided with the required and calculated probability of failure-free operation.

In the *fourth chapter*, a simple and expandable four-step methodology that consolidates approaches for reliability analysis of aircraft systems and structures, prediction of aircraft system faults/failures, optimization of aircraft maintenance task interval using average

operational cost as a measure of efficiency and forecast of spare parts inventory for the optimization of aircraft maintenance processes is developed.

This methodology was developed because scattered standalone interventions may increase total downtime. The proposed methodology launches the basis for further developments in terms of its future expansion, validation, and implementation. Its uniqueness resides in the fact that while most studies focus on individual components or systems, the proposed methodology considers all aircraft components and systems in a single framework. In addition, this data-driven approach is a more cost-effective alternative to physics-based modelling and can be utilized for developing data-driven aircraft prognostics frameworks. Furthermore, insights from its usage can be beneficial in solving the maintenance optimization problem from the design phase of the aircraft life cycle.

The *conclusions* present the main results of the dissertation research, which reflect the methodological foundations of the models and algorithms for optimizing aircraft maintenance processes.

The scientific novelty of the primary results obtained during the research is as follows:

1. For the first time, statistical simulation models for reliability analysis that can be applied to both large and small aircraft datasets were developed. The reliability indices obtained can improve the reliability-centered and condition-based maintenance framework.
2. For the first time, segmented regression models were developed to predict flight hour at which an aircraft component, subsystem, or system will fail. This is necessary because wrong maintenance predictions and configuration strategies can lead to untimely support, flight delays, or aircraft on the ground.
3. For the first time, optimal aircraft maintenance task interval was determined using average operational cost as a measure of efficiency. The model was developed based on reliability probability density functions, cost of corrective aircraft maintenance, and cost of preventive aircraft maintenance. Existing optimal maintenance task models use the maintenance cost rate as an optimization criterion but overlook the reliability performance.

Reducing the system maintenance cost rate does not imply that the system reliability performance is optimized in terms of cost, specifically for multicomponent systems. Minimal maintenance cost is sometimes associated with reduced system reliability measures; this is one of the outcomes of having different components in the system, which may have various maintenance costs and different importance to the system. This forms the basis for the development of this model.

4. For the first time, a model that considers the historical trend of component failures and reliability parameters for forecasting spare parts inventory was developed. This is especially important for operations in countries like Nigeria because there are limited original equipment manufacturers and spare parts storage facilities available. In addition, spare parts performance deteriorates over time in hot standby, warm standby, and even cold standby. They can also suddenly fail due to external shocks and degradations resulting from imperfect storage (storage failure).

5. For the first time, a concise methodology that integrates reliability parameters, failure prediction, cost, and spare part inventory forecast was developed to optimize aircraft maintenance processes for continuing airworthiness. This is particularly important for implementing the strategies proposed in this study as a single framework instead of existing standalone models that result in prolonged planning and waste. Furthermore, the models and algorithms proposed were validated using real operational aircraft data from airlines and helicopter operators in Nigeria. As a result, these models can be scaled to multiple systems without needing specific domain knowledge. In addition, this data-driven approach is a more cost-effective alternative to physics-based modeling and can be utilized for developing data-driven aircraft prognostics frameworks.

The practical value of the results obtained in the dissertation are as follows:

1. A technique for reliability analysis based on exponential distribution given a dataset > 35 ; allows aircraft operators to analyze data components, subsystems, systems, and structures. An operator can compare the reliability of the entire fleet to understand the

cost of schedule interruptions, analyze solutions, and prioritize service bulletins based on impact on the fleet.

2. A technique for reliability analysis given a dataset < 35 ; is significant because small datasets produce large confidence intervals at high total flight hours, implying lower statistical reliability; a key disadvantage of using a small dataset is the lack of statistical stability. The proposed technique is based on Kazakyavicius equation; the failure rate is determined using the probability of failure-free operations.
3. A technique for predicting the flight hour at which a failure will occur in an aircraft's components, subsystems, systems, and structures. This is significant because wrong maintenance predictions and configuration strategies can lead to untimely support, flight delays, or aircraft on the ground.
4. A technique for determining optimal aircraft maintenance interval using average operational cost as a measure of efficiency. The proposed model is based on Erlang's probability density function of time between the failures and considers maintenance cost and reliability. It also quantifies the corrective and preventive maintenance costs alongside the maintenance benefits to obtain an optimum balance between both.
5. A technique for forecasting aircraft spare parts inventory for non-repairable items and exponentially distributed time between the failures. The quantity of spare parts is calculated using the required probability of failure-free operation and the estimated failure rate value obtained from real statistical data analysis. This is significant because excess spare parts inventory results in a high holding cost and impedes cash flows. In contrast, a lack of spare parts can lead to costly flight delays or cancellations, negatively impacting airline performance.
6. A concise, simple, and expandable four-step methodology that integrates all the proposed techniques for the optimization of aircraft maintenance processes. This methodology is considered a novel theoretical framework for performance-centered aircraft maintenance, which considers the operational performance and the condition of aircraft components, subsystems, systems, and structures.

The results of this research may be used in formulating maintenance optimization problems and developing a data-driven predictive maintenance approach from the design phase of the aircraft life cycle.

Keywords: aircraft, aircraft maintenance, optimization, maintenance optimization, reliability, reliability analysis, regression, segmented regression, probability, statistics, predictive analytics, machine learning, data processing, efficiency, expert system, statistical simulation, Monte Carlo, aircraft systems, aircraft components, aircraft structures, aircraft subsystems, failure rate, mean time between failure, time between failures, probability density function, technical condition, diagnosis, decision-making, spare parts, preventive maintenance, predictive maintenance, corrective maintenance, data-driven, dataset.

LIST OF PUBLICATIONS

Publications included in the international scientometric database (Scopus)

1. Okoro O.C., Zaliskyi M., Dmytriiev S., Solomentsev O., Sribna O. Optimization of Maintenance Task Interval of Aircraft Systems. *International Journal of Computer Network & Information Security*. 2022. Volume 14. No 2. P. 77–89.

Author's contribution: development of stochastic mathematical models using diagnostic variables and reliability parameters to determine optimal aircraft maintenance task interval.

2. Okoro O.C., Zaliskyi M., Serhii D., Abule I. An approach to reliability analysis of aircraft systems for a small dataset. *Scientific Journal of Silesian University of Technology. Series Transport*. 2023. Volume 118. P. 207–217.

Author's contribution: development of a model for the reliability analysis of aircraft components, subsystems, systems, and structures given a small dataset which is typical of small-scale aircraft operations.

3. Zaliskyi M., Okoro O.C., Dmytriiev S., Fayoyiwa O.S.. Software Support for Simulation and Prediction of Failures and Faults During Aircraft Operations. Lecture Notes in Networks and Systems. 2023. Volume 736. P. 247–259.
Author's contribution: development of software framework for predicting failures and malfunctions of aircraft components, subsystems, systems, and structures.
4. Zaliskyi M., Yashanov I., Okoro O.C., Shcherbyna O. Analysis of Learning Efficiency of Expert System for Decision-Making Support in Aviation. Advanced Computer Information Technologies (ACIT): Proceedings of IEEE 12th International Conference, Ruzomberok (Slovakia). 26-28 September 2022. P. 172–175.
Author's contribution: efficiency analysis of different expert system for decision-making support in aircraft operations.
5. Okoro O.C., Chukwu C.N., Zaliskyi M., Holubnychyi O. A Method for Planning Spare Parts Inventory During Aircraft Operation Advanced Computer Information Technologies (ACIT): Proceedings of IEEE 12th International Conference, Ruzomberok (Slovakia). 26-28 September 2022. P. 168–171.
Author's contribution: development of methodology for aircraft spare parts planning using statistical data of times to failure of aircraft components.
6. Okoro O.C., Zaliskyi M., Dmytriiev S., Qudus S. Data-Driven Approach to Optimal Aircraft Maintenance. The International Council of the Aeronautical Sciences: Proceedings of 33rd Congress, Stockholm (Sweden). 4 – 9 September 2022. P. 7114–7124.
Author's contribution: development and synthesis of statistical data processing algorithms and models to improve the efficiency of aircraft maintenance.

Publications in scientific and specialized Ukrainian Journals

7. Okoro O.C. Reliability Analysis of Aircraft Fleet in Nigeria. Proceedings of National Aviation University. 2020, Volume 83 (2). P.49–53.
Author's contribution: analysis of reliability indicators of aircraft and helicopters in Nigeria.

8. Огоро О. Ч., Дмитрієв С. О., Заліський М. Ю., Осіпчук А. О. Моделі для аналізу надійності авіаційних компонентів, систем та конструкцій повітряних суден. Системи управління, навігації та зв'язку. Збірник наукових праць. 2022. Том 4 (№ 70). С. 16–21.

Author's contribution: development of a statistically simulated reliability model that can be applied during the design and development of components, systems, and structures of helicopters.

9. Огоро О.Ч., Дмитрієв С. О., Заліський М. Ю., Осіпчук А. О. Статистичні імітаційні моделі оптимізації технічного обслуговування повітряних суден. Системи управління, навігації та зв'язку. Збірник наукових праць. 2022. Том 3 (№ 69). С. 8–12.

Author's contribution: development of a statistical simulation model of failures of aircraft systems and structures using the Monte Carlo method.

Publications in collections of conference materials

10. Okoro O.C. Optimization of Aircraft Maintenance Processes Using Regression Analysis. Current Security Problems in Transport, Energy, and Infrastructure: Proceedings of Conference, Kherson. 2021. P. 244.

Author's contribution: development of a linear regression model for failure prediction of aircraft systems and components using aircraft operations data from Nigeria.

11. Okoro O.C., Zaliskyi M., Dmytriiev S. Statistical simulation regression models for efficient aircraft operations. Aviation in the XXI-st century - Safety in aviation and space technology: Proceedings of The Tenth World Congress, Kyiv. 28 – 30 September 2022. P. 1–5.

Author's contribution: development of segmented regression models for precise prediction of the occurrence of failures of aircraft components, systems and structures using daily operation aircraft data.

12. Zaliskyi M., Okoro O.C., Dmytriiev S. Statistical Simulation of Failures of the Systems and Structures of S-76 C++ Helicopters in Nigeria. Cyber Hygiene & Conflict

Management in Global Information Networks: Proceedings of 2nd International Conference, Kyiv-Lviv. 30 November 2020. P. 1–10.

Author's contribution: development of a statistical model for failure simulation of aircraft components.

13. Okoro O.C., Zaliskyi M., Dmytriiev S. Statistical Simulation Models for the Optimization of Aircraft Maintenance Processes. Problems of Transportation Organization and Air Transport Management: Proceedings of International Scientific-Practical Conference, Kyiv, NAU, 20 October 2021. P-3.

Author's contribution: development of methodology for determining the optimal time interval for the maintenance of aircraft.

14. Okoro O.C., Zaliskyi M., Dmytriiev S. Models for Optimizing Aircraft Maintenance Processes. Condition-based Maintenance in Aerospace: Proceedings of 1st International Conference, Delft (Netherlands). 24 – 25 May 2022. P. 1–10.

Author's contribution: Numerical examples for estimating optimal time interval for preventive and predictive aircraft maintenance using exponential probability density function.

15. Okoro O.C., Zaliskyi M. Models and Algorithms for Optimizing Aircraft Maintenance Processes. Air Transport Research Society: Proceedings of 25th World Conference, Antwerp (Belgium). 24 – 27 August 2022. P. 1 – 5.

Author's contribution: Numerical examples for estimating optimal time interval for preventive and predictive aircraft maintenance using Erlang probability density function.

16. Okoro O.C., Zaliskyi M. Optimizing Aircraft Maintenance Processes – An Operations Data-Driven Methodology. Ontario Aircraft Maintenance Conference; The Future of Aircraft Maintenance – Performance, Professionalism and Pride: Proceedings of Conference, Toronto, (Canada). 2-3 November 2022. P.1-18.

Author's contribution: development of simple and concise methodology for practical application of data-driven predictive aircraft maintenance.

17. Okoro O.C., Zaliskyi M., Dmytriiev S. An Approach to Optimizing Aircraft Maintenance. In: Karakoc, T.H., Atipan, S., Dalkiran, A., Ercan, A.H., Kongsamutr, N., Sripawadkul, V. (eds). Research Developments in Sustainable Aviation. ISSA SARES 2021 (Proceedings of International Symposium on Sustainable Aviation, Bangkok, Thailand). Sustainable Aviation. 2023, Springer, Cham, pp. 263–269.

Author's contribution: development of optimized maintenance task intervals of aircraft systems using the average operational cost per unit time as a measure of efficiency.

TABLE OF CONTENTS

ABBREVIATIONS	17
INTRODUCTION	18
CHAPTER 1: OVERVIEW OF AIRCRAFT MAINTENANCE IN NIGERIA AND ANALYSIS OF EXISTING METHODS FOR OPTIMIZING AIRCRAFT MAINTENANCE GLOBALLY	25
1.1 Overview of aircraft maintenance in Nigeria.....	25
1.1.1 Aircraft maintenance processes in Nigeria.....	27
1.1.2 Existing maintenance philosophies	30
1.2 Existing models for optimizing aircraft maintenance	32
1.2.1 Aircraft maintenance planning models	32
1.2.2 Aircraft maintenance scheduling models.....	36
1.2.2 Aircraft maintenance task allocation models	40
1.2.4 Aircraft maintenance routing models	42
1.2.5 Spare parts planning models for aircraft maintenance	45
1.2.6 Aircraft maintenance personnel and skill management models	47
1.2.7 Aircraft maintenance models based on prognostics and health management data.....	49
1.2.8 Reliability-centered maintenance models for aircraft maintenance.....	49
1.2.9 Research motivation	52
1.3 Numerical reliability analysis of aircraft in Nigeria.....	53
1.3.1 An overview of aircraft reliability.....	53
1.3.2 Numerical reliability analysis of aircraft in Nigeria	54
1.3.3 Analysis of results of numerical reliability indicators using the bathtub curve	64
CONCLUSIONS	66
CHAPTER 2: MATHEMATICAL MODELLING FOR THE OPTIMIZATION OF AIRCRAFT MAINTENANCE PROCESSES FOR CONTINUING AIRWORTHINESS	69
2.1 Use of daily aircraft operations data for statistical data processing algorithms	69
2.3 Algorithms and models for reliability analysis of aircraft components, subsystems, systems, and structures	73
2.3.1. Statistical simulation models for aircraft reliability analysis	75
2.3.2. Statistical simulation model for reliability analysis given a small dataset.....	79
2.4 Mathematical models for the optimization of aircraft maintenance task intervals.....	83

2.4.1 Methodology for the optimization of aircraft maintenance task interval.....	83
2.4.2 Mathematical modelling of exponential model of time between failures to determine an optimal aircraft maintenance task interval	85
2.4.3. Mathematical modelling of Erlang model of time between failures to determine an optimal aircraft maintenance task interval	86
2.4.4 Methodology for determining an optimal aircraft maintenance task interval	87
2.5 Regression mathematical model for predicting the occurrence of aircraft component, subsystem, or system failures.....	89
2.5.1 Regression analysis models for optimizing aircraft maintenance.....	90
2.5.2 Quadratic-linear segmented regression model.....	91
2.5.3 Linear-linear segmented regression model	92
2.5.4 Quadratic-quadratic segmented regression model	92
2.6 Mathematical models for forecasting aircraft spare parts	93
2.6.1 Reliability-centered models for aircraft spare parts management	95
CONCLUSIONS	98
CHAPTER 3. ANALYSIS OF PROPOSED MATHEMATICAL MODELS FOR THE OPTIMIZATION OF AIRCRAFT MAINTENANCE PROCESSES FOR CONTINUING AIRWORTHINESS.....	101
3.1 An overview of predictive aircraft maintenance	101
Data-driven predictive aircraft maintenance.....	102
3.2. Reliability analysis of aircraft components, subsystems, systems, and structures given a large dataset	103
3.3 Reliability analysis of aircraft components, subsystems, systems, and structures given a small dataset.	109
3.4. Optimal regression model for predicting time moment of aircraft component, system, or structure's failure.....	113
3.5 An approach to optimizing maintenance task interval of aircraft components, subsystems, systems, or structures.....	117
3.6. Planning spare parts inventory during aircraft operation	119
CONCLUSIONS	124
CHAPTER 4. A CONCISE METHODOLOGY FOR OPTIMIZING AIRCRAFT MAINTENANCE PROCESSES FOR CONTINUING AIRWORTHINESS OF AIRCRAFT IN NIGERIA	127
4.1. Justification of the proposed methodology for the optimization of aircraft maintenance processes for continuing airworthiness	127

4.2. Overview of the proposed four-step methodology for optimizing aircraft maintenance processes for continuing airworthiness	130
4.2.1. Step 1 – Statistical simulation to determine reliability parameters.....	131
4.2.2. Step 2 – Statistical simulation to predict the flight hour at which a failure will occur in an aircraft component, subsystem, system, or structure	131
4.2.3. Step 3 – Estimate the optimal maintenance task interval using average operational cost as a measure of efficiency	132
4.2.4. Step 4 – Forecast the spare parts inventory for aircraft operations.....	133
4.3 Technique for the calculation of reliability indices of aircraft systems and components	133
4.4 Technique for predicting the flight hour at which a failure will occur in aircraft component or system	135
4.5 Estimation of the optimal aircraft maintenance task interval	136
4.6 An optimized approach for forecasting spare parts inventory of aircraft operations.....	138
4.7 Advantages of the proposed four-Step methodology for the optimization of aircraft maintenance processes for continuing airworthiness	139
CONCLUSIONS	141
RESEARCH CONCLUSIONS	143
APPENDIX 1	166
APPENDIX 2	170

ABBREVIATIONS

ACSSS	Aircraft Components, Subsystems, Systems and Structures
AI	Artificial Intelligence
AIB	Accident Investigation Bureau
AMOPAM	Aircraft Maintenance Operations Performance Assessment Model
AMP	Aircraft Maintenance Planning
AOG	Aircraft on Ground
ATA	Air Transport Association
CBM	Condition Based Maintenance
CDF	Cumulative Distribution Function
CM	Corrective maintenance
COSL	Component Operating and Storage Limits List
DSS	Decision Support System
FAAN	Federal Airport Authority of Nigeria
FR	Failure Rate
IATA	International Air Transport Association
ICAO	International Civil Aviation Organization
MCS	Monte Carlo simulation
ML	Machine Learning
MPD	Maintenance Planning Document
MRO	Maintenance Repair and Overhaul
MSG	Maintenance Steering Group
MTBF	Mean Time Between Failures
NAMA	Nigeria Airspace Management Agency
NCAA	Nigeria Civil Aviation Authority
NigCARS	Nigeria Civil Aviation Regulations
NFF	No Faults Found
OEM	Original Equipment Manufacturers
OS	Operational System
PDF	Probability Density Function
PdM	Predictive maintenance
PHM	Prognostics and Health Management
PM	Preventive maintenance
RAMS	Reliability, Availability, Maintainability, and Safety
RCM	Reliability Centered Maintenance
SARPs	Standards and Recommended Practices
TBF	Time Between the Failures

INTRODUCTION

The relevance of the dissertation topic. The operations phase of the aircraft life cycle is the most expensive; it costs 10-20 times the design and manufacturing phase. For instance, in Nigeria, even though domestic and international passenger traffic has grown tremendously recording a post-COVID-19 pandemic annual growth rate of 43.41% and 57.61%, respectively [1], aircraft maintenance costs are still significantly higher than the global average. Aircraft operators spend 75% of the estimated \$1 billion annual cost in West Africa [2]; this justifies the need for a shift away from traditional maintenance actions, which are corrective or preventive.

Corrective Maintenance (CM) tasks are connected to run-to-failure maintenance strategies, while Preventive Maintenance (PM) work is performed as part of a fixed interval to replace, repair, or restore. It includes work carried out under a fixed-interval restoration/repair strategy and conducted based on a time or machine-run-based schedule that detects, precludes, or mitigates degradation [3]. Unfortunately, these traditional aircraft maintenance strategies lack predictive capability and often lead to maintenance being performed too early, i.e., before the end of a machine's useful life, or too late, i.e., after a costly failure [4]. Therefore, the aviation industry needs realism in mathematical models, and the way optimization problem is formulated; system reliability, maintenance processes, and cost must be considered from the design phase of the aircraft lifecycle [5].

Recent research highlights that statistical data processing algorithms can be used to improve the efficiency of aircraft operations given diagnostic variables and reliability parameters as initial data [6-11]. These algorithms can be developed using statistical data generated from the operations phase of the aircraft lifecycle, which generates a wealth of real-time data, which is collected, transferred, and processed with 70 miles of wire and over 18 million lines of code [12-13]. The resulting algorithms can estimate the time of possible failure with the aim of preventing it based on correct and timely operational actions. Furthermore, the data-driven Predictive Maintenance (PdM) approach based on industry 4.0 techniques will

result in lower maintenance costs, avoid unnecessary PM actions and reduce unexpected failures. A combination of PM and PdM results in 18.5 % less unplanned downtime and 87.3% fewer defects for more reliance on predictive than preventive maintenance [3].

Aim and objectives of the study. The main aim of this study is cost-effectiveness and increased efficiency of aircraft operations from a maintenance point of view using operations in Nigeria as proof of concept.

To achieve this aim, the following objectives are addressed:

- Understand existing aircraft maintenance strategies using the scenario in Nigeria.
- Develop mathematical models that can be implemented to improve the framework of Reliability-Centered Maintenance (RCM) and Condition-based maintenance (CBM) strategies.
- Develop mathematical models for determining optimal flight hour for aircraft maintenance.
- Develop mathematical models for determining the optimal aircraft maintenance task interval.
- Develop mathematical models for a precise forecast of spare parts inventory.
- Increase steady state availability of aircraft components and systems, reduce aircraft downtime, and increase the levels of targeted maintenance.
- Develop a framework that can form the basis for maintenance optimization from the design phase of the aircraft lifecycle.

The research object shall be aircraft maintenance processes, systems, and components.

The research subject data processing algorithms for optimizing aircraft maintenance processes.

Methods of the research. The methods of mathematical reliability theory, probability theory and statistics, machine learning, predictive analytics, numerical analysis, and statistical simulation modeling are used to address the objectives stated.

Scientific novelty of the obtained results.

1. For the first time, statistical simulation models for reliability analysis that can be applied for both large and small aircraft datasets were developed. The reliability indices obtained can improve the framework of RCM and CBM

2. For the first time, segmented regression models were developed for the prediction of flight hour at which an aircraft component, subsystem or system will fail. This is necessary because wrong maintenance predictions and configuration strategies can lead to untimely support, flight delays, or aircraft on the ground.

3. For the first time, optimal aircraft maintenance task interval was determined using average operational cost as a measure of efficiency. The model was developed based on reliability probability density functions, cost of Corrective aircraft maintenance (CM), and cost of Preventive aircraft maintenance (PM). Existing optimal maintenance task models use the maintenance cost rate as an optimization criterion but overlook the reliability performance. Reducing the system maintenance cost rate does not imply that the system reliability performance is optimized in terms of cost, specifically for multicomponent systems. Minimal maintenance cost is sometimes associated with reduced system reliability measures; this is one of the outcomes of having different components in the system, which may have various maintenance costs and different importance to the system. This forms the basis for the development of this model.

4. For the first time, a model which considers the historical trend of component failures and reliability parameters for forecasting spare parts inventory was developed. This is especially important for operations in countries like Nigeria because there are limited Original Equipment Manufacturers (OEM) and spare parts storage facilities available. Furthermore, spare parts performance deteriorates over time in hot standby, warm standby, and even cold standby. They can also suddenly fail due to external shocks and degradations resulting from imperfect storage (storage failure).

5. For the first time, a concise methodology that integrates reliability parameters, failure prediction, cost, and spare part inventory forecast was developed to optimize aircraft

maintenance processes for continuing airworthiness. This is particularly important for implementing the strategies proposed in this study as a single framework instead of existing stand-alone models that result in prolonged planning and waste. Furthermore, the models and algorithms proposed were validated using operational aircraft data and can be scaled to multiple systems without needing specific domain knowledge. In addition, this data-driven approach is a more cost-effective alternative to physics-based modeling and can be utilized for developing data-driven aircraft prognostics frameworks.

The validity and trustworthiness of the obtained research results have been confirmed by the sufficient and proper application of the mathematical apparatus of reliability theory, probability theory and statistics, machine learning, and predictive analytics. In addition, consistency of theoretical results was obtained with operational data from aircraft in Nigeria, as well as the results of statistical simulation modeling.

The practical significance of the obtained results. This dissertation provides a scientific and technical basis for further optimization of aircraft maintenance processes and improved efficiency of aircraft operations. The following practical results of the research have been achieved:

- A technique for reliability analysis based on exponential distribution given a dataset > 35 ; this allows aircraft operators to analyze data components, subsystems, systems, and structures. An operator can compare the reliability of the entire fleet to understand the cost of schedule interruptions, analyze solutions, and prioritize service bulletins based on impact on the fleet.
- A technique for reliability analysis given a dataset < 35 ; this is significant because small datasets produce large confidence intervals at high total flight hours, implying lower statistical reliability; a key disadvantage of using a small dataset is the lack of statistical stability. The proposed technique is based on Kazakyavicius equation; the FR is determined using the probability of failure-free operations.

- A technique for predicting the flight hour at which a failure will occur in an ACSSS. This is significant because wrong maintenance predictions and configuration strategies can lead to untimely support, flight delays, or AOG.
- A technique for determining optimal aircraft maintenance interval using average operational cost as a measure of efficiency. The proposed model is based on Erlang's PDF of TBF and considers both the maintenance cost and reliability. It also quantifies the CM and PM costs alongside the maintenance benefits to obtain an optimum balance between both.
- A technique for forecasting aircraft spare parts inventory for non-repairable items and exponentially distributed TBF. The quantity of spare parts is calculated using the required probability of failure-free operation and the estimated failure rate value obtained from real statistical data analysis. This is significant because excess spare parts inventory results in a high holding cost and impedes cash flows. In contrast, a lack of spare parts can lead to costly flight delays or cancellations, negatively impacting airline performance.
- A concise, simple, and expandable four-step methodology which integrates all the proposed techniques for the optimization of aircraft maintenance processes. This methodology is considered a novel theoretical framework for performance-centered aircraft maintenance which considers the operational performance and the condition of ACSSS.

Personal contribution of the candidate: The main results of the research were obtained by the author independently. As shown in the list of author's publication in the abstract, study [7] were conducted independently by the author. The candidate has made the following contributions in the articles published in co-authorship: in [1] — development and simulation analysis of stochastic mathematical models using diagnostic variables and reliability parameters to determine optimal maintenance task interval of aircraft systems and structures. In [8, 9] — development of statistically simulated exponential model for reliability analysis of aircraft components, systems and structures using daily operations aircraft data. In [4] —

analysis of different learning techniques of expert system based on a probabilistic approach for artificial intelligence-based computer systems to emulate human-expert decision-making for implementing controlled and preventive aircraft maintenance strategies. In [5] — development of method for planning spare parts inventory during aircraft operation based on statistical data of times to failure of aircraft components. In [6] —development and synthesis of statistical data processing algorithms and models to improve efficiency of aircraft maintenance. In [2] — development of statistically significant algorithm and model for reliability analysis of aircraft systems given small data-set typical of small-scale operations. In [3] — development of a new software framework for modeling and forecasting failures and malfunctions of aircraft components, subsystems, systems, and structures.

Approbation of results of the dissertation work. The research results were discussed at 12 international congresses, symposiums and conferences: 1) 2nd International Conference on Cyber Hygiene & Conflict Management in Global Information Networks (Kyiv-Lviv, Ukraine, 2020); 2) 2021 International Symposium on Network Security and Communications (Kyiv, Ukraine); 3) Current Security Problems in Transport, Energy and Infrastructure Conference (Kherson, Ukraine, 2021); 4) 2021 International Scientific-Practical Conference on Problems of Transportation Organization and Air Transport Management (Kyiv, Ukraine); 5) International Symposium on Sustainable Aviation (Bangkok, Thailand, 2021); 6) 1st International Conference for Condition-based Maintenance in Aerospace (Delft, Netherlands, 2022); 7) 25th Air Transport Research Society World Conference (Antwerp, Belgium, 2022); 8) 33rd Congress of the International Council of the Aeronautical Sciences (Stockholm, Sweden, 2022); 9) 10th World Congress “Aviation in XXI-st Century - Safety in aviation and space technology” (Kyiv, Ukraine, 2022); 10) IEEE 12th International Conference on Advanced Computer Information Technologies (Ruzomberok, Slovakia, 2022); 11) Ontario Aircraft Maintenance Conference; The Future of Aircraft Maintenance – Performance, Professionalism and Pride (Toronto, Canada, 2022). 12) International Workshop on Advances in Civil Aviation System Development (Kyiv, Ukraine, 2023).

Publications. The main contents of this dissertation have been published in 17 publications, including 8 proceedings of international congresses, symposiums, and conferences. All publications are indexed in scientometric databases, including 6 in Scopus database.

Structure and content of the dissertation. The dissertation consists of an introduction, four chapters, conclusions, list of used references represented after each chapter, and three appendices. There are a total number of 175 pages – There are 36 figures (including 14 figures on seven separate pages), 17 tables (including seven tables on six separate pages), 174 references on twenty pages and eight pages of appendices.

CHAPTER 1: OVERVIEW OF AIRCRAFT MAINTENANCE IN NIGERIA AND ANALYSIS OF EXISTING METHODS FOR OPTIMIZING AIRCRAFT MAINTENANCE GLOBALLY

1.1 Overview of aircraft maintenance in Nigeria

In Nigeria, even though domestic and international passenger traffic has grown tremendously recording a post-COVID-19 pandemic annual growth rate of 43.41% and 57.61%, respectively [1]; aircraft maintenance costs are still significantly higher than the global average, with aircraft operators spending 75% of the estimated \$1 billion annual cost in West Africa [2]. To maintain flight safety and reliability, aircraft maintenance is regulated by aviation authorities; the Nigerian Civil Aviation Authority (NCAA) is the only aviation regulatory authority in Nigeria [14]. The other bodies in the aviation sector are the Federal Airport Authority of Nigeria (FAAN) Accident Investigation Bureau (AIB), and Nigerian Airspace Management Agency (NAMA); these were created to comply with International Civil Aviation Organization (ICAO) safety regulations.

Part 5 of the Nigerian Civil Aviation Regulations (NigCARs) presents regulatory requirements for the continuing airworthiness of aircraft expected to operate in Nigeria in line with the Standards and Recommended Practices (SARPs) in ICAO Annexes 6 (operation of aircraft) and 8 (airworthiness of aircraft) [15]. An aircraft is considered airworthy if it conforms to its design and is in a condition for safe flight. Conforming to type design defines initial airworthiness while being in a condition for safe flight defines continuing airworthiness. Initial airworthiness determines whether an aircraft or new component part is fit for entry into use [16]. ICAO Annex 8 defines continuing airworthiness as the set of processes by which an aircraft, engine, propeller, or component part complies with the applicable airworthiness requirements and remains in a condition for safe operation throughout its operating life [16-17]. According to ICAO Part M which contains among other things the minimum requirements of maintenance and airworthiness, continuing airworthiness can be defined as all processes that

ensure that at any time in the operating life of an aircraft that it complies with airworthiness requirements and is in a condition safe for operations. Part M represents a compulsory operating license for aircraft operators. It covers minimum requirements for:

1. Maintenance based on an officially approved maintenance program. A maintenance program is a document that outlines scheduled maintenance tasks, their frequency, and related procedures.

2. Fixing any damage that could influence flight safety in addition to performing replacements and repairs based on approved maintenance documents and standards.

3. Evaluating the efficiency of a maintenance program (reliability monitoring).

4. Compliance with Airworthiness Directives and other officially issued measures [18].

The operator is responsible for the continuing airworthiness of an aircraft and shall ensure that no flight takes place unless:

1. The aircraft is maintained in an airworthy condition.

2. Any operational, emergency equipment systems fitted are correctly installed and serviceable or clearly identified as unserviceable.

3. The airworthiness review certificate remains valid.

4. All aircraft maintenance is performed in accordance with the Approved Maintenance program [18].

Aircraft maintenance is a key aspect of airworthiness. Continuing airworthiness maintenance program consists of aircraft inspection, unscheduled and scheduled maintenance, structural inspection program or airframe overhaul, propeller, and auxiliary power unit (APU) repair and overhaul [19]. Aircraft maintenance includes actions and analysis that are performed to improve or maintain the reliability and airworthiness of aircraft systems, subsystems, and components all through the life cycle of the aircraft. Actions that may be carried out in connection with aircraft maintenance include the development of aircraft maintenance programs based on the manufacturer's guidelines, monitoring and implementation of airworthiness directives issued by the NCAA. The NCAA issues a certificate of airworthiness (C of A) on the basis that the aircraft complies with design aspects of the appropriate

airworthiness requirements. A certificate of airworthiness becomes invalid if the aircraft is not maintained in an airworthy condition [14-18].

1.1.1 Aircraft maintenance processes in Nigeria

Various aircraft types are in operation in Nigeria; aeroplanes include but are not limited to B777-200/300, B737-200/300/400/500/700/800, B747-400, A340, ERJ 135/145/190-400, ATR 42/72 etc. The commercial helicopter sector contributes to the economy by providing search and rescue services, and transportation to the offshore oil and gas industry. Helicopter models used in Nigeria include but are not limited S76C/D, S92, AW139 etc. Maintenance of these aircraft is important to operations because it affects dispatch reliability and safety of passengers and cargo.

According to European Committee for Standardization EN 13306, maintenance can be defined as a combination of technical, managerial, and administrative actions during the life cycle of an item with the intention of retaining it in or restoring it to a state in which it can carry out the required functions [20]. Aircraft maintenance is a general term for aircraft checks that assess aircraft and the condition of their component parts and systems. It includes short pre-flight checks or detailed checks of the aircraft components and systems. Effective aircraft maintenance is focused on ensuring that required levels of flight safety and reliability are met and in the case of failure, maintenance restores the safety and reliability levels to required standards [21-24]. Maintenance actions for aircraft components and systems are categorized into Corrective Maintenance (CM), Preventive Maintenance (PM), and Predictive Maintenance (PdM) – Traditional aircraft maintenance methods are corrective and preventive while predictive maintenance is a modern approach based on machine learning principles and prognostics health monitoring (Fig 1.1). CM covers all repair actions for unplanned faults and failures. PM actions reduce the occurrence of unplanned repairs; It consists of periodic maintenance actions to avoid failures and breakdown of components and systems. PdM uses some parameters to speculate when failures may happen thereby reducing the number of

unplanned breakdowns by providing personnel with reliable scheduling options for preventive maintenance [25-27].

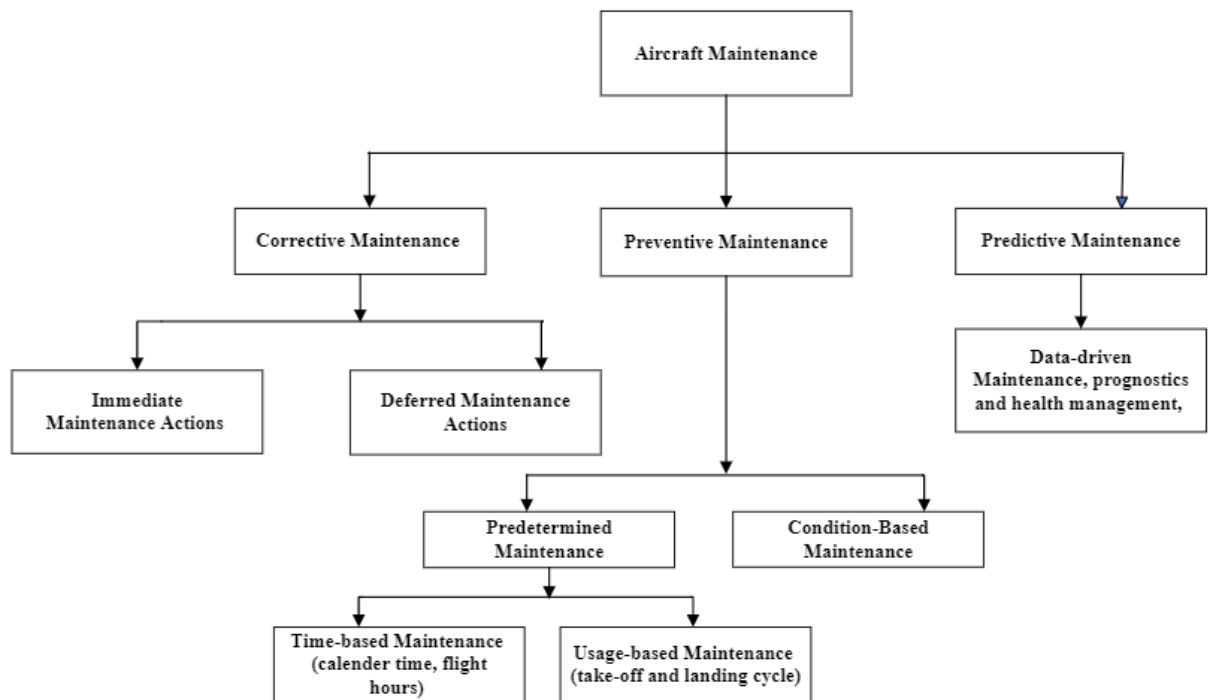

Fig 1.1. Categories of aircraft maintenance

In aviation, PM actions are referred to scheduled maintenance and can be grouped into predetermined and Condition-based Maintenance (CBM) actions; predetermined actions are further categorized into time-based (calendar time, flight hours) and usage-based (take-off and landing cycle) actions. CBM is a maintenance strategy in which maintenance is carried out based on the actual condition and trend of the component without compromising on the regulator's standards. The goal of CBM is to prevent failure and retain the system's condition using intelligent technology that continuously tracks the component condition. Elements of PM actions are inspection, servicing, calibration, testing, alignment, adjustment, and installation. CM actions are called unscheduled maintenance; they are classified into immediate and deferred corrective maintenance. Its elements are fail-repair, salvage, rebuild, servicing and overhaul [19, 26, 28-29].

In accordance with Part 9 of the NigCARs, operators are mandated to provide a maintenance program for each of their aircraft [30]. The maintenance program includes scheduled maintenance tasks and frequencies required by the Maintenance Review Board Report (MRBR) and other mandatory requirements, complemented by additional maintenance tasks considered for their economical effectiveness, reliability improvement as well as for passenger comfort and appearance reasons. The MRBR is a guideline that specifies minimum requirements for the maintenance of an aircraft type. It is a generally approved starting point for creating a maintenance program and is globally accepted by aviation authorities as a key basic maintenance document of an aircraft type. The report is aligned to the world fleet of an aircraft type but at the same time considers different aircraft configurations as well as individual usage behavior and extent [31-33]. The framework of an aircraft maintenance program is usually pre-determined by the manufacturer, but operators must adapt their maintenance program to the respective aircraft configuration and the individual requirements of their fleets. For this reason, the maintenance program of the diverse aircraft types differs in practice; but even with identical aircraft types, the details of maintenance program can vary between airlines, depending on operational area and utilization, or on the individual operational experiences. In addition to that, maintenance programs also reflect more or less clearly the maintenance philosophies of operators (e.g. block or phase-related maintenance, focus on prevention or maximum utilization of permissible limits) [17-18, 31-32].

The aim of a maintenance program is to give guidance to maintenance personnel on regulations, procedures, limitations and/or restrictions pertinent to the safe performance of duties and responsibilities in areas and conditions where aircraft maintenance are conducted and to reflect the maintenance needs of the aircraft that shall be complied with, to ensure continuous safe operation. The maintenance program is part of the approved maintenance system. Other parts of the maintenance system are the Component Operating and Storage Limits List (COSL), supplementary maintenance by accomplishment of service bulletins and airworthiness authority requirements. The maintenance program must be monitored by qualified engineers for suitability at least annually [17-18, 31-32].

TASK REFERENCE (Source Document)	ZONE	DESCRIPTION	THRESHOLD INTERVAL SAMPLE	JOB PROCEDURE	M	M.H	EFFECTIVITY
335000-CHK-10000-1 (MRBR : 335000-03)	200	EMERGENCY LIGHTING VISUAL CHECK OF EMERGENCY EXIT SIGNS AND ESCAPE PATH MARKING FOR CORRECT LUMINESCENCE	I: 2 C	JIC: 335000-CHK-10000 MP: A-33-5X-XX-00ZZZ-360Z-A	1	0,50	ALL
335000-OPT-10000-1 (MRBR : 335000-01)	210	EMERGENCY LIGHTING OPERATIONAL TEST OF EMERGENCY LIGHTS IN AUTOMATIC AND MANUAL MODE	I: 2 A	JIC: 335000-OPT-10000 MP: A-33-5X-XX-00ZZZ-320Z-A	1	0,10	ALL
335121-RAI-10000-1 (MRBR : 335000-02)	200	EMERGENCY LIGHTING REMOVAL OF EMERGENCY LIGHTING BATTERIES FOR CAPACITY CHECK (CFR) Acc :256HW. ***END***	I: C	CFR: CFR CMM: 1. 335122 CMM: 2. 335006 CMM: 3. 335007 CMM: 4. 335126 JIC: 335121-RAI-10010 MP: A-33-51-20-A0ZZZ-520Z-A MP: A-33-51-20-A0ZZZ-720Z-A	1 a	0,50 0,06	ALL

SYSTEMS AND COMPONENTS PROGRAM : EMERGENCY LIGHTING

ISSUE: 5, REV.0,JAN 10, 2021

SECTION : 5-33/5

PAGE : 120

Fig 1.2. Sample page of maintenance program of an aircraft operating in Nigeria [31]

First issues as well as revisions of the maintenance program must be approved by the NCAA and are based on related technical documentations including the MRBR, Maintenance Planning Document (MPD), type certificate holder recommendations, engine maintenance manual, component maintenance manuals, mandatory requirements including airworthiness directives and other applicable requirements from the NCAA, service bulletins, in-service experience and industry recommendations, reliability analysis based on engineering findings, pilot reports, and changes in company procedures that affect the maintenance program [31-32].

1.1.2 Existing maintenance philosophies

In the early stages of aviation history, aircraft maintenance was performed based on the mechanics' experiences. The beginning of the jet age and the creation of aviation safety

authorities paved the way for a paradigm shift which resulted in structured maintenance planned by engineers. Aircraft maintenance was based on hard time principle which is the theory of preventive but expensive replacement or restoration of component parts and systems [19]. Maintenance activities were based on the idea that measures were more effective, the more they were carried out (“much helps much”). In the 1960’s it became evident that this principle was not sufficient because practical experience was not considered in the maintenance schedules. Therefore, for the first time in the context of the development of B747, a systematically planned maintenance program which considered the aircraft or component part’s condition, became the standard; this documentation was produced by Air Transport Association (ATA) Maintenance Steering Group (MSG) and was referred to as MSG [19, 34-35].

MSG was focused on conducting a logical decision process for cost-effective and efficient routines acceptable to manufacturers, operators, and regulators. The MSG process allows defects to occur and relies upon the analysis of information about such defects to determine the appropriate actions. MSG evolved to MSG-2 which was designed in a document released by the ATA in the 1970s. MSG and MSG-2 processes follow a bottom-up approach while MSG-3 follows a top-down approach and was built based on the framework of MSG-2. MSG-2 is a decision logic technique which streamlines scheduled maintenance requirements by capitalizing on the inherent reliability of aircraft systems and equipment using condition monitoring. In the top-down approach of MSG-3, consequences of component failure and how aircraft operations are affected is the focus. Application of RCM also known as MSG-2 was introduced to the aviation industry in 1974 by United Airlines and the United States Department of Defense. It has been successfully implemented in offshore oil industry and nuclear power. Aircraft operators in Nigeria typically follow either the MSG-2 or MSG-3 philosophy of maintenance [34-35]

1.2 Existing models for optimizing aircraft maintenance

According to International Air Transport Association (IATA), global aircraft maintenance, repair and overhaul expenditure totaled \$69 billion in 2018, with an annual growth rate of 4.1% therefore aircraft operators are constantly searching for ways to decrease these expenses without compromising on flight safety and reliability levels [36]. Aircraft maintenance optimization is typically a multi-objective solution that aims to maximize revenue by maintaining high availability while simultaneously minimizing cost [37]. To optimize aircraft maintenance, many researchers have suggested and tested a range of techniques based on aspects of aircraft maintenance processes such as planning, scheduling, maintenance task allocation, aircraft maintenance routing, spare parts inventory, personnel, and skill management. Other techniques use aircraft prognostics and health management data, and reliability models. The following sub-sections will explain these aspects of aircraft maintenance, the optimization techniques suggested by researchers and, advantages and limitations of their studies.

1.2.1 Aircraft maintenance planning models

Proper, reliable and flexible planning can directly contribute to the efficiency of maintenance [38]. However, in practice, aircraft utilization is manually managed and on a day-to-day basis resulting in a reactive approach to allocation of aircraft flight hours in which problems with respect to availability, sustainability and serviceability can easily develop [39]. Furthermore, existing Aircraft Maintenance Planning (AMP) methods effectively outline maintenance work with regards to where in the aircraft it is expected to be carried out, when in the maintenance intervention it is expected to occur, or what technical skills are needed [40]. This is mostly due to various constraints such as maintenance resources, operational demand, locations, facilities etc. [39].

Scheduled aircraft maintenance tasks are performed at predetermined intervals hence the work is typically deterministic while on the other hand, unscheduled tasks, result from the carrying out scheduled activities and depends on the probabilistic nature of failures, hence is classified as inherently stochastic and are characterized only at the end of the aircraft inspection. This results in uncertainty regarding maintenance work and capacity problems in which planned resources are insufficient or otherwise excessive to carry out the maintenance work [40]. A decision support tool (Fig 1.3) can handle the stochastic nature of executing maintenance tasks and is generated using a combination of reliability analysis, cost analysis, decision alternative generation and ranking. Depending on parameter settings, this framework can aid operational maintenance planning and potentially reduce maintenance costs by 45 to 90%. However, this tool doesn't consider manpower availability, and task deferral, including extension of the planning horizon beyond the next maintenance check. By analyzing real-time data on work progress, this decision support framework can be used to monitor the progression of planned aircraft maintenance thereby exploring optimal task planning in the event of delays or maintenance being ahead of schedule [38].

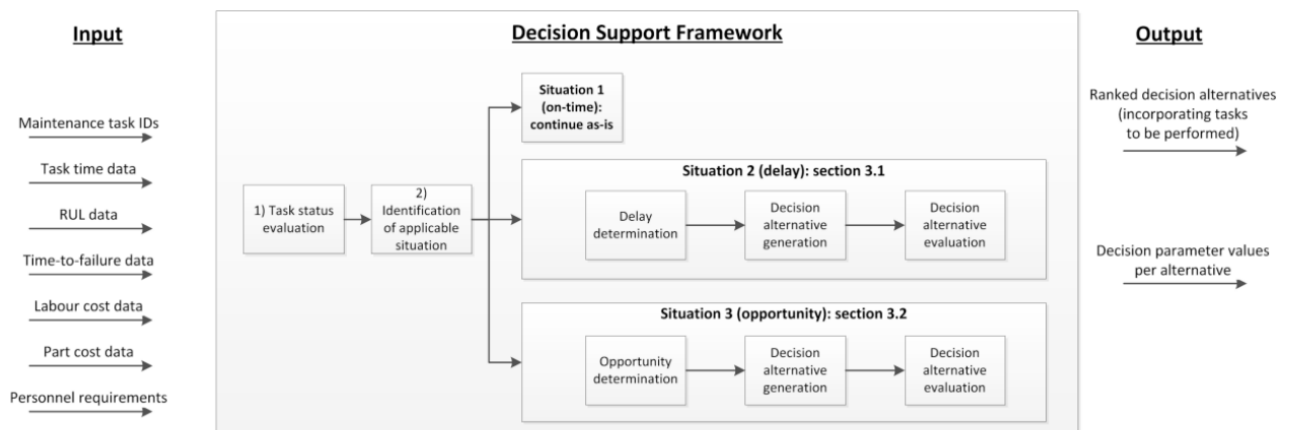

Fig 1.3. Decision support framework for maintenance planning [38]

Traditionally, operators carry out hangar maintenance for its own fleet, but with the rapid growth of air transport demand, operators increasingly outsource hanger maintenance to

maintenance service companies. These companies upon receiving an order, need to determine maintenance schedules, aircraft movement path, parking stand allocation and staff assignment which can be integrated in a mixed-integer linear programming model. This model formulates geometric constraints and manpower assignment constraints is proposed to integrate and characterize the interdependent relationship of decision-making. However, the model doesn't consider the aircraft arrival patterns to avoid congestion of maintenance requests [41].

Considering that a significant portion of maintenance work is stochastic in nature, a method for data analysis titled 3-dimensional maintenance data analysis to generally characterize the expected maintenance work based on a space-time-skill coordinate system (Fig. 1.4) in which indicators are determined from historical data. In the context of this methodology, space (j) refers to aircraft work zone where maintenance is carried out, time (k) refers to the project work phase when maintenance is performed, and skill (i) refers type of technicians required for maintenance to be carried out [40].

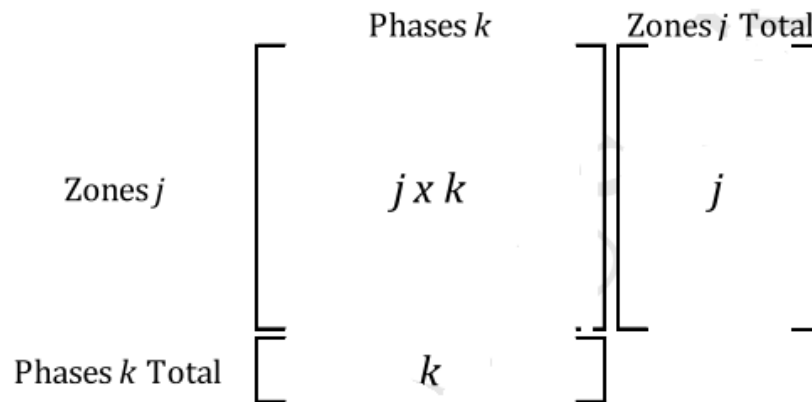

Fig 1.4. Matrix for the maintenance work characterization of skill i [40]

An aircraft is considered available if it is not undergoing any maintenance operations and has enough flight hours to be assigned to a mission. Aircraft availability can also be considered in terms of the amount of flight hours left before mandatory maintenance [42]. In [43] the authors analyzed the process of AMP and developed an optimization model for aircraft

maintenance based on the objective function of cost minimization. Their proposed model which was solved using genetic algorithm didn't consider the special constraints of an old aircraft, major festivals and closing times of station but they assumed the flight plan was known and that any aircraft can operate at an airport.

For the long-term planning of maintenance and flight operations, the authors in [42] generated scenarios inspired by the French Air Force fleet and formulated an exact mixed integer programming model to solve the problem in these scenarios. Although the study showed that the mathematical model's performance is robust in terms of increase in fleet size, size of the planning horizon and flight missions, the addition of consumption outside of flight mission proved challenging. On the other hand, gains in resolution time were obtained by developing a construction heuristic that provided starting solutions for the cases where an integer solution was not easily obtained by the model.

In [44], a Decision Support System (DSS) automates the AMP process and in one single solution, provides optimization of maintenance check scheduling, optimal task allocation, and shift planning. In comparison to current airline practices in Europe, the DSS can improve aircraft utilization and minimize maintenance costs. Time needed for AMP is reduced from hours or days to 20–30 minutes.

Operational aircraft maintenance planning models

Unscheduled maintenance can result in costly delays and cancellations if the problem is not rectified in a timely manner. Aircraft operability is considered a major prerequisite by each airline operator. It refers to the aircraft's ability to meet the operational requirements in terms of operational reliability, operational risk, and costs [39, 45]. Short-term planning technique of line maintenance activities also support decision making for deferring maintenance actions that affect dispatch of aircraft [45].

Operational readiness is influenced by aircraft downtime and characterized by three primary components: availability, serviceability, and sustainability [39, 45]. The flight and maintenance planning optimization framework (Fig 1.5) which doesn't cover the entire scope of operational readiness, simultaneously addresses the three primary components of

operational readiness resulting in a pro-active, efficient, and more robust scheduling effort i.e., schedules that can deal with delays related to the stochastic flight arrival times [39].

An Aircraft Maintenance Operations Performance Assessment Model (AMOPAM) can assess the differences in performance between two different scenarios of aircraft maintenance operations and can capture these differences both in the form of differential- (ΔV) and financial value (Net Present Value). This model was applied to test material unavailability only at KLM Engineering & Maintenance and an insight on how the model responds in different environments was not studied. The input variables for AMOPAM are Key Performance Indicators (KPIs) that have been identified as value drivers that can capture the operational and financial performance of aircraft maintenance procedures. The KPIs are costs, revenue, punctuality of maintenance check, technical delays and cancellations, aircraft on ground orders and outstanding deferred defects [46].

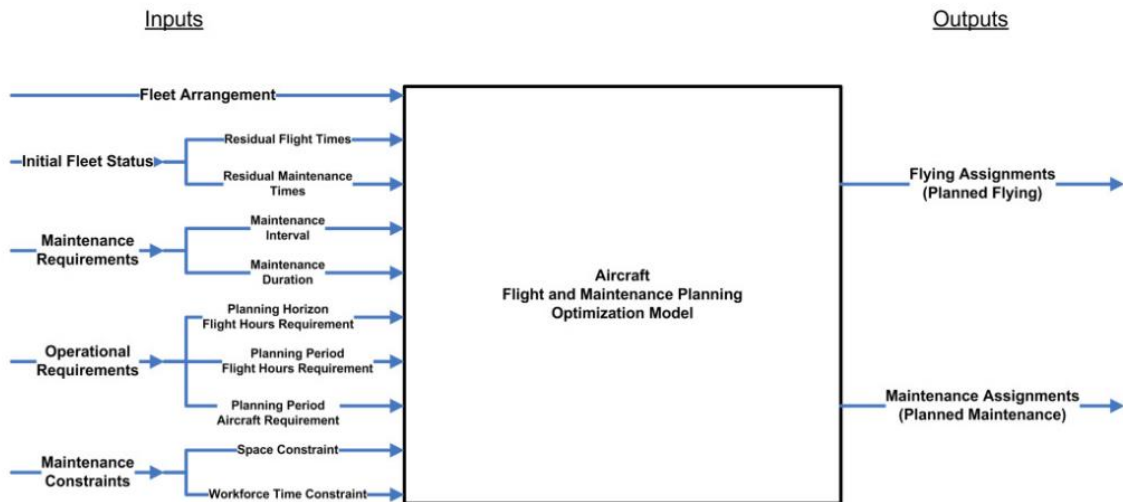

Fig 1.5. Aircraft flight and maintenance planning optimization framework [39]

1.2.2. Aircraft maintenance scheduling models

Maintenance costs are typically affected by factors such as multiple types of aircraft in the fleet which increase the costs of aircraft maintenance due to poor management of aircraft

material and poor maintenance schedules. Maintenance scheduling and rescheduling is a key element in achieving the reliability, availability, maintainability, and safety standard of aircraft operations [47]. An optimal maintenance schedule satisfies the following conditions: fleet availability meets operator's demand; aircraft components can be put to great use; maintenance resources are evenly distributed [37]. Scheduling maintenance inspection for a large heterogeneous fleet is typically a complex and demanding problem. Aircraft maintenance schedules are typically prepared based on the experience of maintenance operators. The traditional approach is time-consuming, can result in poor solutions, decrease the aircraft utilization and increase aircraft maintenance cost [48].

A heuristic approach which considers origin destination pairs rather than flight legs provides a good solution for maintenance scheduling in reasonable computation time and can be used by mid-sized airline corporations [49]. An innovative condition-based maintenance scheduling methodology which integrates complex data processing, prognostic algorithm, feature extraction and maintenance scheduling optimization can provide a more predictable and efficient maintenance scheduling capability. Although aircraft fleet availability and the optimal maintenance schedules change over different levels of maintenance capacity, the framework of prognostic-based maintenance scheduling which can be solved by IBM CPLEX Optimizer which provides a tradeoff analysis in terms of key performance metrics such as cost and capacity expansion [47]. An optimization method which integrates aircraft maintenance tasks packaging and scheduling in the aircraft life cycle models the concept of prognosis-based maintenance. This approach is based on branch-and-bound algorithm for maintenance planning and a discrete-event simulation of aircraft operation but doesn't factor applicability for different airline business models e.g., low-cost carrier or network [50].

Management must decide on the timing of maintenance between arrival and departure of the aircraft [51]. Inspection interval decisions are traditionally based on deterministic analysis of crack propagation which may require too frequent or infrequent inspection and sometimes result in rapid crack propagation than expected [52]. Aircraft fleet reliability increases as inspection frequency or inspection quality increases. However, this is

accompanied by an increase in cost of inspection and maintenance thereby leading to a potential tradeoff between fleet reliability and the cost of inspection and maintenance [53]. The stochastic crack growth analysis method based on the equivalent initial flaw size distribution algorithm after which failure risk was determined compensates for the shortcomings of deterministic analysis applied during traditional inspection intervals [52]. An optimization method for aircraft periodic inspection and maintenance on the zero-failure data analysis solves the problem of excessive maintenance and reduces aircraft unserviceable time.

To deal with uncertainties connected with maintenance, aircraft operators work with safety buffers which are defined by the due time associated with each job. The ideal size of these buffers can be determined using the techniques which depends on the uncertainty of the operation and the desired level of service to achieve. This way the goal of the maintenance problem can be redefined as scheduling jobs as close to their due dates as possible which means that deviation from the 'ideal' schedule determined by due dates is minimized [36]. An aircraft maintenance-scheduling model solved by artificial bee colony algorithm can establish an optimal maintenance date for each type of aircraft. This model considers aircraft materials and other factors as constraints, and aircraft on ground (AOG) loss is set as the goal function. Objective function is related to the loss of AOG in the entire maintenance cycle, and constraints ensure that every maintenance time is covered by the time window. The set of constraints ensure that the maintenance check should not affect commercial operation of the fleet while considering the material resources, human hours, and check capabilities available. The objective of this model is to minimize AOG and maximize efficiency, but it doesn't consider the constraints of operating a heterogenous fleet [54].

A Fleet Maintenance Decision-making Model (Fig. 1.6) based on Condition-based Maintenance (FMDM-CBM) in combination with Collaborative Optimization (CO) not only minimizes fleet maintenance costs and maximizes availability but also considers the different conditions of aircraft structures. The effectiveness of this algorithm for fleet maintenance planning was demonstrated using a fleet of ten aircraft and results showed that incremental maintenance cost was reduced by 70.65%. The fleet maintenance costs are reduced in parallel

sub-systems using CO algorithm, considering maintenance capacity constraints at the system level. On the other hand, the system level focuses on maximizing fleet availability and balancing the fleet maintenance plan with maintenance resources over the planning horizon [55].

Using a practical dynamic programming-based methodology for the optimization of long-term maintenance check schedule, the number of maintenance checks for a fleet of heterogeneous aircraft can be reduced by around 7% over a period of four years, with a computation time of less than 15 minutes. With the goal of reducing wasted flight hours interval between checks, this methodology integrates different check types (A, B, C and D checks) in a single schedule but doesn't consider uncertainty associated with both the maintenance check elapse times and the aircraft utilization which not only affect the robustness of the schedule but also the computational time needed to calculate the optimal schedules [48].

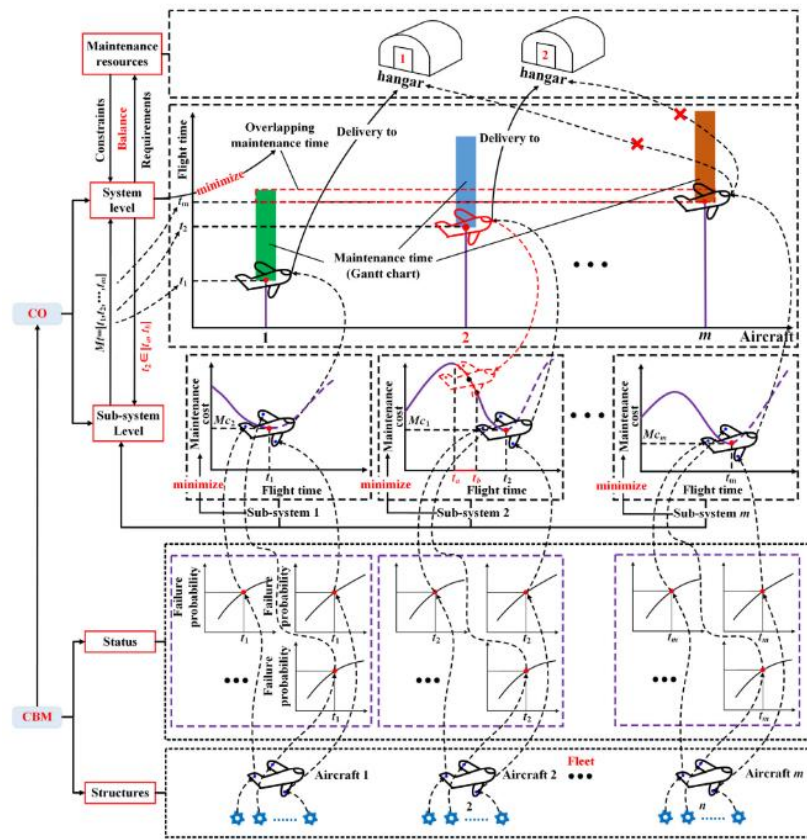

Fig 1.6. Framework of FMDM-CBM [55]

The framework proposed in [56] doesn't consider complications that may arise from some of the long-term maintenance types but can construct a near-optimal aircraft maintenance schedule within minutes. This framework involves two multi-objective mixed integer linear programming formulations and an iterative algorithm to develop maintenance schedules, and commercially viable and maintenance feasible flight. In the first formulation, the Airline fleet Maintenance Scheduling (AMS) with violations reduces the number of maintenance regulation violations and the number of aircraft which are not airworthy. The second formulation is the AMS with tail assignment which allows aircraft to be assigned to various flights.

1.2.2 Aircraft maintenance task allocation models

Maintenance planners are faced with the daily challenge of optimal allotment of aircraft maintenance tasks to the best maintenance opportunities. The typical approach followed is to group tasks into maintenance checks (e.g., A-, B-, C- and D-check) to establish a logical maintenance program in which all tasks are carried out before their associated due dates. Combining aircraft maintenance tasks into work packages is not only fundamental for organizing maintenance activities, but also critical for minimizing maintenance cost. To determine the optimal start dates of the tasks, it is usual practice to adopt a sequential process. Although some tasks can quickly be packaged into these letter checks, a considerable number of other tasks (more than 70% for an Airbus A320 aircraft) are de-phased from the intervals of these checks. This means that they either have to be assigned to a more recurrent letter check or manually allocated by maintenance operators to various maintenance events based on the suitability of the task to that check and the importance of performing the task in due time. In practice, both approaches are conducted based on the experience of maintenance planners, leading to inefficiencies [44, 57-58].

Task Allocation Problem (TAP) in aircraft maintenance refers to the process of optimally allocating tasks in predetermined maintenance checks. It determines the optimal start dates of aircraft maintenance tasks so that all preventive tasks are carried out as close to their

due dates as possible. Due to its combinatorial nature, TAP is complicated and has to be simultaneously solved for the entire fleet. In real-life applications, multiple aircraft checks can be scheduled in parallel, and tasks assigned to these checks will share the maintenance resources [58]. A combinatorial maintenance model based on maintenance cost rate and solved by adaptive genetic algorithm based on cluster search combines various tasks into an optimal work package during the decision-making phase of aircraft maintenance. However, it takes a long time to converge to an accurate solution around the extreme point [59].

The authors in [58] defined TAP as a Time-Constrained Variable-sized Bin Packing Problem (TC-VS-BPP), expanding the notable variable-sized bin packing problem (VS-BPP) by including intervals, deadlines, and arrivals for the repetition of tasks (Fig 1.7).

Algorithm 1 Task Allocation Algorithm.

```

1:  $N \leftarrow$  set of task items from all aircraft,  $N = \cup N_k$ 
2:  $\overline{GR}_t^j \leftarrow$  available labor hours from skill  $j$  in bin  $t$ 
3:  $GR_{i,k}^j \leftarrow$  amount of labor hours of skill  $j$  prescribed to perform
   task item  $i$  of aircraft  $k$ 
4:  $\sigma_{j,m} \leftarrow$  "non-routine rate" from skill  $m$  from every hour of skill  $j$ 

5: procedure SORT TASK ITEMS LIST
6:   Sort and reindex  $N$  so that  $p(i_1) \geq p(i_2) \geq \dots \geq p(i_n)$   $\triangleright$ 
   Prioritization of task items
7: end procedure

8: procedure TASK ITEMS LOOP
9:   while  $N \neq \emptyset$  do
10:     Select  $i$  from  $N$   $\triangleright$  Select the first task in the list
11:      $R_t \leftarrow R_{i,k} \cup t_0$   $\triangleright$  Add  $t_0$  as a fictitious opportunity
12:     Sort and reindex  $R_t$  so that  $\sum_{j \in J} \overline{GR}_{t,1}^j \geq \sum_{j \in J} \overline{GR}_{t,2}^j \geq \dots \geq$ 
        $\sum_{j \in J} \overline{GR}_{t,n}^j$ 
13:     procedure ALLOCATE TO BIN
14:        $n \leftarrow 0$ 
15:       while  $n < |R_t|$  do
16:          $n \leftarrow n + 1$ 
17:         if  $\overline{GR}_t^j \geq \sum_{j \in J} GR_{i,k}^j \times \sigma_{j,m} \quad \forall m \in J$  then
18:           Allocate  $i$  to  $t_{i,n}$ 
19:           Set  $\overline{GR}_{t,n}^j = \overline{GR}_{t,n}^j - \sum_{j \in J} GR_{i,k}^j \times \sigma_{j,m} \quad \forall m \in J$ 
20:           Compute next due-date for task item  $i$ 
21:           if Next due-date not within time horizon then
22:              $N \leftarrow N \setminus \{i\}$   $\triangleright$  Remove the maintenance task
23:           else
24:             Sort Task Items List
25:           end if
26:           break
27:         end if
28:         if  $n = |R_t|$  then  $\triangleright$  In case of no allocation possible
29:           Allocate  $i$  to  $t_0$ 
30:           Report Alert
31:         end if
32:       end while
33:     end procedure
34:   end while
35: end procedure

```

Fig 1.7. Task allocation algorithm [58]

The planning horizon is split into variable size bins to which multidimensional tasks are allotted based on available labor power and task deadlines. They proposed a constructive heuristic based on the worst-fit decreasing (WFD) algorithm for TC- VS-BPP. This approach doesn't consider the stochasticity connected with the TAP problem but can efficiently solve the multi-year task allocation problem for a fleet of aircraft in few minutes and is approximately 30% faster for all the airline test cases considered.

Line maintenance activities can interrupt routine aircraft operation due to frequency of their occurrence. Furthermore, frequent opening and closing of panels results in significant wear and tear, thereby reducing the inherent reliability of the aircraft. A simulation model which predicts the maintenance requirements of an aircraft in an airline operating under known condition can be used to group maintenance tasks into manageable packages that can be performed at extended maintenance intervals and within specified periods thereby increasing aircraft availability. This model can also be used to vary and adapt line maintenance packages in case an aircraft visits the hangar for non-routine maintenance [60].

1.2.4 Aircraft maintenance routing models

The assignment of route to an aircraft while considering its maintenance requirements is called Aircraft Maintenance Routing Problem (AMRP) [61]. AMRP determines the route of individual aircraft (tail number) in an array of revenue flight legs, such that each route will have adequate opportunities for the needed maintenance tasks to be carried out [62]. Fast and simple polynomial-time algorithms can be used for finding a routing of aircraft in a graph whose routings during the day are fixed. A polynomial-time algorithm can find a Euler tour that represents a routing in Lines of Flying (LOF) graph. The algorithm is embedded into a three-stage routing system that creates LOFs to satisfy all the necessary conditions for the existence of a maintenance routing [63]. Given a set of flight legs for a specific aircraft type with the specified maintenance locations and known remaining flying hours, a combination of breadth first search and Dijkstra's algorithm generates the most optimal maintenance feasible

routes. Maintenance cost is significantly reduced while factoring in the maintenance requirements such as slot availability, availability of man hours and turn-around time of aircraft [61].

A hybrid optimization-simulation approach based on a novel mixed-integer nonlinear programming model can be used for robust weekly aircraft maintenance routing problem. This approach integrates mixed-integer programming with Monte-Carlo simulation to obtain robust aircraft schedules thereby improving on-time performance, while satisfying maintenance constraints and stochastic delays. In comparison with the traditional airline approach, this model improved on time performance by 9.8–16.0% and reduced delays by 25.4–33.1% [64].

In [62], an interactive mechanism between aircraft routing and maintenance planning decisions is suggested for reducing maintenance misalignment usage. A formulation of AMRP in which maintenance requirements are designed as generalized capacity constraints, ensuring satisfactory maintenance opportunities are feasible within the planned routes to meet the maintenance demands of individual aircraft. To generate the week-length routes per individual aircraft, the AMRP is initially formulated as a new integer programming (IP) model. A capacity planning-based strategy is applied to build the generalized maintenance constraints whereby sufficient maintenance opportunities (or capacity) must be available within the planned routes to satisfy the projected maintenance workload due. However, the limitation of this mechanism is that doesn't consider uncertainty due to unscheduled maintenance demand and unforeseen aircraft grounding.

A multi-integer linear programming model (Model I) for AMRP with the goal of minimizing the number of aircraft and total remaining flying time was developed in [65]. Model I was then extended to Model II and Model III. In Model II, the authors considered the robustness based on the likelihood of aircraft delay and then added the robust constraints to the model with the aim of reducing total aircraft delay costs. For Model III, the authors considered the fleet type of aircraft, whose aim is to reduce the total flying cost. In terms of solution method, they improved a heuristic of the variable neighborhood search (VNS) algorithm to solve the Model I and Model II which can quickly generate a suboptimal solution in reasonable

time. Experimental results demonstrated that Model I can effectively solve the AMRP by arranging the necessary routine maintenance for the aircrafts to ensure the safety of the flights. Based on this, the flight mission can be achieved with the minimum number of aircraft and the least total remaining flying hours of the aircrafts, which increases the utilization of the aircrafts. Based on the probability of the flight delay, Model II can achieve a robust airline flight scheduling plan with the ability to resist disturbance by adding more cushion time.

Operational aircraft maintenance routing models

Airlines periodically revise aircraft routes through the Operational Aircraft Maintenance Routing Problem (OAMRP). The OAMRP determines the route for each individual aircraft while integrating operational maintenance considerations and this short-term planning problem requires building aircraft routes that satisfy maintenance requirements [66, 67]. To address this problem, branch-and-price algorithm can be used because of the resource constraints which require a modification of the branch-on, follow-on branching rule generally used for solving similar problems [68]. To maximize utilization of the total remaining flying time of aircraft fleet, an integer linear programming (ILP) model which doesn't consider crew scheduling was formulated by modifying the connection network representation and is solved using branch-and-bound under various priority settings for variables to branch on. Based on compressed annealing (CA), a heuristic method is applied to the OAMRP, and a comparison of exact and heuristic methods show that CA is effective in quickly finding high quality solutions. The CA returns feasible solutions within the first two minutes and reduces the number of lost flight opportunities values to acceptable amounts at the end of the first hour which is key to providing the responsiveness needed by the airline industry. A rolling horizon-based procedure updates the existing routes where some maintenance decisions are already fixed [69].

An exact mixed-integer programming model that consists of a polynomial number of variables and constraints can solve the OAMRP. Although this model also doesn't consider crew pairing, evidence shows that it delivers optimal solutions for example with up to 354 flights and 8 aircraft, and that the heuristic approach generally delivers high-quality solutions. A graph reduction procedure and valid inequalities that improve solvability of the model [67].

In [66] OAMRP was studied with two objectives. First, the authors formulated a mixed integer linear programming model that considers all operational maintenance requirements. The proposed model is solved using commercial software for small size problems. Second, they develop a solution algorithm that quickly and efficiently solves the model while tackling medium and large-scale problems. The performance of the proposed solution algorithm is checked based on real data from an airline, the results show high quality solutions and significant savings in computational time. The results of this study demonstrate that the performance of the proposed algorithm exceeds those of the existing methods such as CA and considers the capacity of the maintenance workforce. However, because the OAMRP was considered deterministic, this model wouldn't be exactly useful in real life because aircraft operators typically face disruptions and unforeseen circumstances.

A Flight Delay-based OAMRP (OAMRPFDD) with a limited scope of four days was proposed in [70]; A joint optimization model for a coordinated configuration a scenario-based OAMRPFDD and Maintenance Staffing Problem (MSP) using the Stackelberg game. In this game, the scenario based OAMRPFDD is handled by the airline and plays the leader's role for reducing the propagated delay cost. A bi-level optimization model is used to present the game and is solved by a bi-level nested ant colony optimization algorithm. The MSP, which is handled by the maintenance company, performs the role of the follower that reacts logically to the leader's decision regarding the departure time of the airline's aircraft from the maintenance company.

1.2.5 Spare parts planning models for aircraft maintenance

Spare parts guarantee the safe and economic operation of aircraft and serve aircraft maintenance planning, but unnecessary spare part delivery is a result of incorrect choice of the maintenance strategy. An excess of spare parts inventory results in a high holding cost and impedes cash flows, while lack of spare parts can lead to costly flight delays or cancellations which negatively impact airline performance [71-73]. Aircraft maintenance waiting time can

be reduced by 10.34% and total inventory budget decreased by 12.55% using a model which considers the total spare part provision cost as a constraint to optimize aircraft average waiting time. A heuristic algorithm then solves the model based on analysis of marginal utility of spare parts unit cost [74].

Maintenance decisions and provision of spare parts can be simultaneously carried out for aircraft deteriorating parts [75]. A planning method based on queuing theory and Vari-Metric model can also be used to deploy aircraft spare parts and ground maintenance equipment thereby solving the multi-echelon inventory allocation problem with finite repair capacity for civil aviation [76].

Reinforcement learning driven maintenance strategy (Fig 1.8) is designed to process the future requirement of aircraft mission, spare components storage, repair costs and aircraft PHM output. Limitations of this approach lie in the fact that its development was based on only one aircraft and scenarios for multiple types of planes were not considered. In addition, the aircraft for this research was considered as one-line replaceable unit which can be repaired as good as new; this is not a logical maintenance scenario [37].

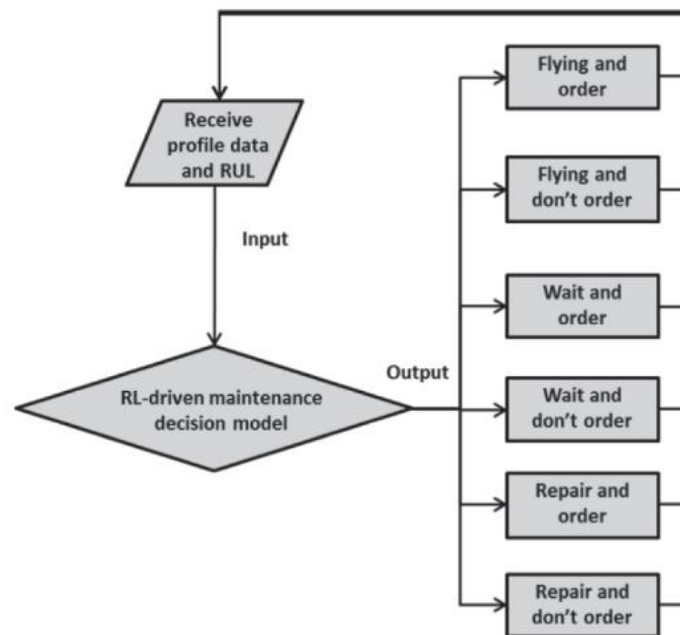

Fig 1.8. Reinforcement learning driven maintenance strategy [37]

A multi-objective simulation optimization framework which integrates multi-objective evolutionary algorithm with multi-objective computing budget allocation method can be used to solve the aircraft spare parts allocation problem to provide a non-dominated Pareto set of solutions to the decision makers. This solution framework also handles the uncertainty involved in performance measures for aircraft maintenance planning by efficiently searching for the non-dominated designs over the solution space [77]. Two non-linear programming models forecast impending demands based on installed parts failure distribution. The optimal order time and quantity can be found by minimizing total cost [72].

1.2.6 Aircraft maintenance personnel and skill management models

Aircraft maintenance resources consist of equipment, materials, and a set of labor hours from various skills [58]. Labor is generally a significant percentage of expenditure therefore an efficient scheduling of the workforce is important [78]. A good personnel schedule ensures that all flights can be maintained with the workers available and their respective skills [78-79]. However, management decisions on timing of maintenance between arrival and departure of the aircraft, constraints by labor union agreements, and stochastic arrival delays resulting in insufficient maintenance personnel capacity are problems associated with scheduling aircraft maintenance personnel. A model enhancement heuristic which optimizes a mixed integer linear programming model with a stochastic service level constraint can be used to build robust aircraft maintenance personnel rosters that attains optimal service level while reducing the total labor costs [40]. Hall's marriage theorem can help decision makers to manage the assignment of skills to maintenance activities while considering complex restrictions [80].

Through communication and reasoning among agents, a multi agent-based fleet maintenance personnel configuration method (Fig 1.9) can be used to solve the problem of aircraft fleet maintenance personnel configuration thereby leading to an optimal maintenance strategy. In the process of configuration of fleet maintenance personnel, the model systematically considers the interaction between human error, cooperation among personnel

and concurrent maintenance [81]. A three-stage mixed integer programming approach provides optimization of the skill mix and training schedule. In the first and second stage, a trade-off is made between the training costs and the resulting cheaper workforce schedule while in the third phase, an optimal and feasible training schedule obtains the desired skill mix with minimal costs. Results based on data from a maintenance repair and overhaul services provider located in Europe show that the model can find good solutions in reasonable computation times. The model provides an excellent tradeoff between cheaper rosters that need higher skilled workers and the training costs to obtain this higher skilled workforce. The downside of this approach is the assumption that during training, workers are unavailable to work but in practice, this is only applicable if the required training can be carried out without posing a threat to the current aircraft maintenance operations [78].

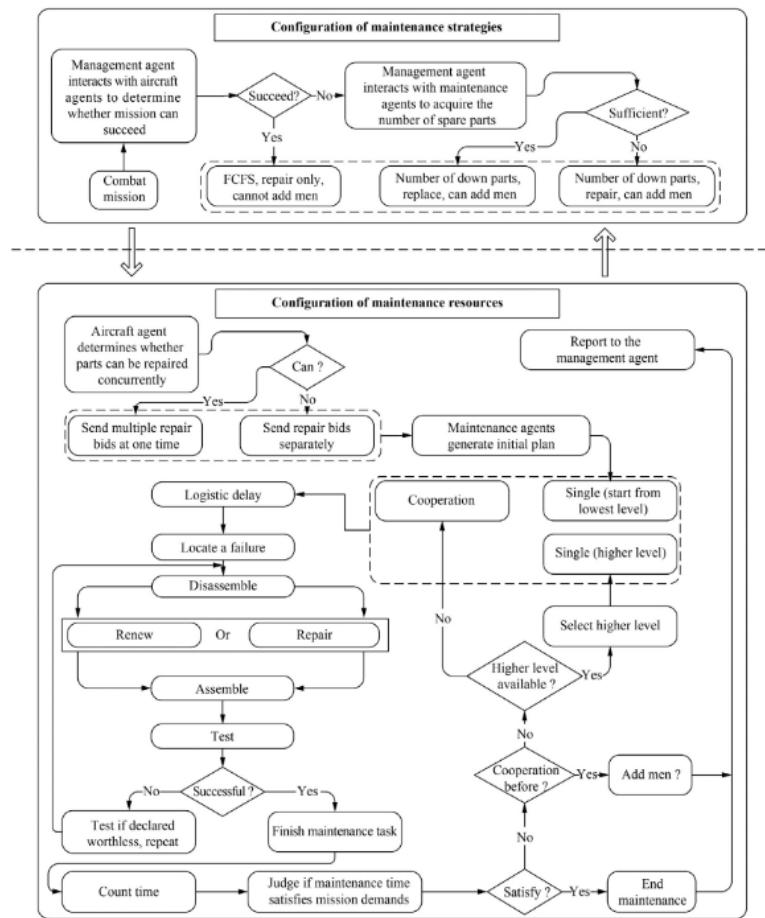

Fig. 1.9. Fleet maintenance decision making based on multi-agent [81]

1.2.7 Aircraft maintenance models based on prognostics and health management data

Prognostics and Health Management (PHM) technology estimates the Remaining Useful Life (RUL) and health state of systems and components. PHM is made up of a set of techniques that use measurement analysis to assess health state and forecast imminent of the monitored equipment's. Advancements in PHM technology in the aeronautical sector has been of value to aircraft manufacturers, aircraft operators, Original Equipment Manufacturers (OEM) and, maintenance, repair, and overhaul service providers to achieve important competitive advantages such as minimized operational cost and increase in fleet reliability [82-83]. A combination of system architecture information and RUL estimations for all components in the system allows for the overall estimation of system-level RUL (S-RUL). The S-RUL information can be used to support maintenance decisions with regards to the replacement of multiple components [82-83]. Deterioration trends and future wear values of aeronautical systems are estimated by considering an implementation of a multiple model approach of the extended Kalman filter technique [84].

1.2.8 Reliability-centered maintenance models for aircraft maintenance

Reliability-centered maintenance (RCM) models allow for the calculation of system reliability considering different kinds of maintenance checks and their intervals thereby providing information for optimizing operational cost, safety, and reliability. Typical framework of RCM includes data collection, including mean time to failure and failure rate function, failure mode and effect analysis, and preventive maintenance interval optimization [85-86].

In [85], a practical approach for analysis of aircraft systems was proposed. This analytical model can be used to determine maintenance check intervals, optimize redundancy and aircraft minimum equipment list. The authors assumed that Markov homogeneous process

can be used as a mathematical model for determining the reliability of aircraft system if a correlation can be established between the state of aircraft systems, their probabilities of failure, failure rates of the element on one hand and on the other hand, Markov process, process transit rates and state probabilities. In addition to these, checks and repairs should be considered. A model of Markov homogeneous process shows that the probabilities of the states of aircraft system can be presented as a product of two multipliers. The first one which depends on flight duration and failure rates of component can be determined using Markov processes and Boolean logic. The second one depends on the check and repair intervals for the components and system states, as well as the flight phase limits. Probability of system failure in any flight was determined using (1.1)

$$Q_z(0, t_{fl}) = (1/M) \sum_{j=1}^M \{Q_z(0, jt_{fl}) - Q_z(0, (j-1)t_{fl})\} \quad (1.1)$$

$$Q_z^0(0, t_{fl}) = \lambda_\alpha \lambda_\beta \dots \lambda_\rho \lambda_\sigma t_{fl}^r / r! \quad (1.2)$$

$$K_z = (r! / t_{fl}^r) (1/M) \sum_{j=1}^M \{Ir(j t_{fl}) - Ir((j-1) t_{fl})\} \quad (1.3)$$

where Q_z – probability, t_{fl} – flight duration, M – number of flights between full system restoration at the j -th maintenance check, $\lambda_\alpha, \lambda_\beta, \lambda_\rho, \lambda_\sigma$ – element failure rates, r – number of failures which moved the system from serviceable condition to the given state, K_z – coefficients of the system maintenance policy effect on the system failures' probabilities.

The first factor (1.2) defines the probability of in-flight system failure state H_z which occurs under a condition of restoring serviceability of all failed elements before take-off. The second factor (1.3) does not depend on the element's reliability λ_μ and shows how much the probability Q_z increases with actual values of the check intervals for the corresponding system states. Optimization of maintenance intervals was carried out in main stages; 1) determination of unreliability and cost functions; 2) optimization of individual maintenance task intervals using Lagrange's method for convex functions; 3) estimation of logical maintenance task

intervals by integrating tasks with optimal values into appropriate scheduled maintenance check with known bases intervals using rank values.

To optimize aero-engine maintenance, the authors in [87] proposed a methodology which evaluates the reliability of an aircraft engine or its module by considering condition monitoring parameters, pilot reports or data history. The mean time between failures is calculated based on these results and maintenance tasks are planned based on the lead time. These actions improve the likelihood of implementing Lean and Six sigma principles in maintenance of aircraft or aero engines through RCM. The proposed methodology consists of 5 stages: data analysis; reliability estimation; estimation of parameters; implementation of the lean and six sigma tools for cost optimization; and control chart to compare the failure rates. For the data analysis, randomized block design is used to model (1.4) to observe the significant difference between and within the engine. Reliability estimation is carried out using Weibull distribution, New Weibull distribution (NWD) and Exponential Inverted Weibull distribution (EIWD) after which an estimation of parameters for the NWD and EIWD is performed.

$$Y_{ij} = \mu + \alpha_i + \beta_j + \varepsilon_{ij} \text{ for } i=1, 2, \dots \text{ and } j=1, 2, \dots, b \quad (1.4)$$

where Y_{ij} – observation connected to the i -th treatment and j -th block

The optimization of PM interval for aircraft indicators by reducing the expected long-term cost of operations based on the reliability information of aircraft indicators was proposed by [86]. The authors identified major failure modes of two indicator applications from two suppliers using information from failure mode and effect analysis (FMEA) reports. Mean time to failure (MTTF) and mean time between unscheduled replacement (MTBUR) metrics were determined and used as inputs for the preventive maintenance interval optimization model. The MTBUR under PM was evaluated using (1.5). The optimal PM schedule is obtained by minimizing the average cost rate (1.6)

$$MTBUR = \sum_{n=0}^{\infty} R(T_0)^n \int_0^{T_0} R(t) dt \quad (1.5)$$

where $\sum_{n=0}^{\infty} R(T_0)^n$ is an infinite geometric series, RT_0 is between 0 and 1.

$$\text{Average rate cost} = \frac{\min C_0 R(T_0)^2 + C_{loss} (R(T_0) - R(T_0)^2)}{(1 - R(T_0)) \int_0^{T_0} R(t) dt} \quad (1.6)$$

1.2.9 Research motivation

Decision frameworks and models based on planning, scheduling, maintenance task allocation, maintenance routing, spare parts inventory, personnel, and skill management have been proposed by researchers for the optimization of aircraft maintenance processes. However not much attention has been paid to reliability theory models, machine learning, regression models and, probability and statistics theories for optimizing aircraft maintenance in the first three phases of aircraft lifecycle. Aircraft systems and components may have inherent failures and their reliability may vary based on previous scheduled checks and repairs. Therefore, a concise understanding of the interaction between reliability levels and historical trends of faults and failures will significantly improve the design, manufacturing, and operation of aircraft. Furthermore, in the aviation industry, realism is needed in mathematical models and the way optimization problem is formulated; system reliability, maintenance processes, and cost must be considered from the design phase of the aircraft lifecycle. For this study, data from aircraft in Nigeria will be used to validate the mathematical models developed for the optimization of aircraft maintenance processes for continuing airworthiness.

1.3 Numerical reliability analysis of aircraft in Nigeria

1.3.1 An overview of aircraft reliability

Aircraft are expensive industrial systems which at the same time have the highest reliability and safety requirements [88]. Maximizing aircraft availability and minimizing cost are best achieved by designing the aircraft to be reliable and maintainable. Therefore, reliability requirements are typically determined during the research and development phase of the aircraft life cycle and is applied to other 3 phases of the aircraft life cycle: manufacturing and acquisition, operation and support, and disposal. During the operation and support phase, reliability of the aircraft and its components is of paramount importance to flight safety and availability. The reliability process allows aircraft operators to analyze data of aircraft and component part. An operator can compare its reliability to the entire fleet to understand the cost of schedule interruptions, analyze solutions, and prioritize service bulletins based on impact to the fleet [89]. For practical purposes, reliability is defined as the ability of a component part, subsystem, or system to perform as intended without any failure and within predetermined performance limits for a defined time interval, in its lifecycle conditions [90]. From a quantitative point of view, reliability is typically evaluated as the probability that a device performs its function for a required period, under specified environmental and operational conditions [91].

An aircraft is a complex combination of subsystem, systems and component parts which are never 100% reliable because sometimes they fail; these failures can more usually be repairable or catastrophic. Therefore, the goal of an aircraft operator is to retain or restore the reliability levels of an aircraft at a minimum cost using a Reliability Control Program (RCP); The RCP of any aircraft focuses on maintaining failure rates below a predetermined value [92]. Reliability theory and methodologies have developed via several phases and there are 3 main areas that evolved during this growth process: 1) reliability engineering, which consists of system reliability analysis, design review, and related task; 2) Operation analysis, which

consists of failure investigation and corrective action; 3) Reliability mathematics, which consists of statistics and related mathematical knowledge [19].

All 3 areas of reliability theory and methodologies will be explored for this study which studies the optimization of maintenance processes for the continuous airworthiness of aircraft in Nigeria.

1.3.2 Numerical reliability analysis of aircraft in Nigeria

Reliability analysis evaluates the probability of the failure of component parts, subsystems, or systems, in the presence of randomness. In mathematical framework, it is formulated using random variables to model variability sources in product and process developments [93]. Considering that optimization of maintenance requires reliability models to find the maintenance strategy where the cost of repairs, inspection and other consequences are minimal, mathematical models using reliability parameters will be developed throughout this study. To get a brief overview of reliability levels of aircraft components and systems in Nigeria, a numerical reliability analysis to determine numerical reliability parameters of aircraft systems is carried out in this chapter. The aircraft systems were categorized using the ATA Spec 100 numbering system which is a world-wide standard for defining and structuring all sections of modern passenger aircraft.

The analysis was carried out using data provided by airlines, helicopter operators and the NCAA. Data for helicopters: seven S-76c++ and four S-92, and aeroplanes: two ERJ-135, two ATR 42-300, one ATR-72 and three MD-83 for the period 2014 – 2018 were used. For the context of this study the term ‘failure’ refers to faults and failures of aircraft component, subsystems, systems or structure, the reliability parameters are defined as follows:

1. Time t which is the sum of flight hours of each aircraft fleet for the stated time interval extracted from the utilization report.

2. Mean time between failures T_{Σ} , which is computed as ratio between the time t to the cumulative number of failures n which occurred during the stated time interval; failure data of aircraft systems were gotten from the aircraft technical log.

3. Failure rate λ_{Σ} refers to the frequency at which a system or component develops a fault or fails. It is computed as the i.e., the inverse ratio of the mean time between failures.

4. Number of failures per 1000 flight hours K_{1000} which is computed as λ_{Σ} multiplied by 1000.

5. Sum of failures which occurred during flight and those observed during maintenance for the corresponding ATA for the stated interval is denoted by n_T

6. Failures in flight for the corresponding ATA for the stated interval is denoted by n_F

Table 1.1

Formular for numerically calculating the reliability parameters

Parameter	Formular
Mean time between failure T_{Σ}	t/n
Failure rate λ_{Σ}	$1/T_{\Sigma}$
Number of failures per 1000 flight hours K_{1000}	$1000 n/t$

Table 1.2

Failure information of S-76 helicopters for the period 2014 – 2018

ATA	ATA Chapter Name	n_T	n_F
21	Air conditioning	11	3
22	Auto flight	104	49
23	Communications	39	12
24	Electrical power	57	20
25	Equipment/furnishings	27	2
26	Fire protection	15	
28	Fuel	9	3
29	Hydraulic power	46	3
30	Ice and rain protection	14	4
31	Indicating/recording systems	31	18
32	Landing gear	211	16
33	Lights	76	16

Continuation of table 1.2

34	Navigation	173	91
39	Electrical - electronic panels and multipurpose components	9	2
45	onboard maintenance system	17	1
51	Structures	70	3
52	Doors	53	7
53	Fuselage	165	21
55	Stabilizers	13	
56	Windows	4	
65	Tail rotor drives	192	8
66	Folding blades	37	4
67	Rotors flight control	76	12
71	Power plant	24	2
72	Engines	20	6
73	Engine fuel and control	48	16
74	Engine ignition	1	
75	Engine air	54	18
76	Engine controls	5	1
77	Engine indicating	8	6
78	Engine exhaust	4	
79	Engine oil	48	1
80	Starting	15	3
Cumulative failures for the stated Interval		1676	348

Table 1.3

Failure information of S-92 helicopters for the period 2014 – 2018

ATA	ATA Chapter Name	n_T	n_F
21	Air conditioning	35	13
22	Auto flight	25	10
23	Communications	22	8
24	Electrical power	25	4
25	Equipment/furnishings	19	
26	Fire protection	12	4
28	Fuel	5	
29	Hydraulic power	19	2
30	Ice and rain protection	9	3
31	Indicating/recording systems	21	1
32	Landing gear	59	4
33	Lights	23	5
34	Navigation	37	11
44	Cabin Systems	2	1
49	Airborne auxiliary power	11	1
50	Cargo and Accessory Compartments	2	

Continuation of table 1.3

51	Structures	2	1
52	Doors	48	11
53	Fuselage	39	3
54	Nacelles/pylons	6	
55	Stabilizers	2	
56	Windows	1	
62	Main rotors	76	2
63	Main rotor drives	33	4
64	Tail rotor	83	2
65	Tail rotor drives	7	1
67	Rotor flight control	28	2
71	Power plant	13	1
72	Engines	4	1
73	Engine fuel and control	2	
74	Engine ignition	15	2
75	Engine air	4	
76	Engine controls	4	1
78	Engine exhaust	9	
79	Engine oil	4	
80	Starting	5	
Cumulative failures for the stated interval		712	98

Table 1.4

Failure information of ERJ-135 aeroplanes for the period 2015 – 2018

ATA	ATA Chapter Name	n_T	n_F
21	Air conditioning	25	6
22	Auto flight	5	1
23	Communications	45	15
24	Electrical power	27	5
25	Equipment/furnishings	56	17
26	Fire protection	9	2
27	Flight controls	40	21
28	Fuel	7	2
29	Hydraulic power	7	2
30	Ice and rain protection	20	13
31	Indicating/recording systems	36	20
32	Landing gear	149	38
33	Lights	109	13
34	Navigation	50	14
35	Oxygen	11	
36	Pneumatics	25	15
38	Vacuum	4	

Continuation of table 1.4

45	Onboard Maintenance Systems	1	
49	Airborne auxiliary power	22	8
52	Doors	10	2
53	Fuselage	7	1
55	Stabilizers	4	
56	Windows	6	
57	Wings	7	1
71	Power plant	3	
72	Engines	4	1
73	Engine fuel and control	6	4
74	Engine ignition	2	
75	Engine air	3	3
76	Engine controls	2	1
77	Engine indicating	1	
78	Engine exhaust	6	3
79	Engine oil	1	
80	Starting	5	2
Cumulative failures for the stated interval		716	210

Table 1.5

**Failure information of ATR 42-300 aeroplanes for the period
June 2016 – December 2018**

ATA	ATA Chapter Name	n_T	n_F
21	Air conditioning	24	8
23	Communications	11	4
24	Electrical power	21	5
25	Equipment/furnishings	5	2
26	Fire protection	3	1
27	Flight controls	3	2
28	Fuel	6	1
29	Hydraulic power	2	1
30	Ice and rain protection	8	1
31	Indicating/recording systems	4	1
32	Landing gear	156	45
33	Lights	48	14
34	Navigation	25	12
35	Oxygen	2	
36	Pneumatics	3	
38	Vacuum	4	
42	Integrated Modular Avionics	1	
51	Structures	1	
52	Doors	5	2

Continuation of table 1.5

53	Fuselage	1	
56	Windows	1	
57	Wings	2	
61	Propellers/ Propulsors	1	
72	Engines	16	5
73	Engine fuel and control	2	1
77	Engine indicating	3	1
79	Engine oil	1	
Cumulative failures for the stated interval		359	106

Table 1.6

Failure information of MD-83 aeroplanes for the period 2015 – 2018

ATA	ATA Chapter Name	n_T	n_F
21	Air conditioning	734	670
22	Auto flight	142	119
23	Communications	321	272
24	Electrical power	250	152
25	Equipment/furnishings	1869	1752
26	Fire protection	85	38
27	Flight controls	104	87
28	Fuel	62	30
29	Hydraulic power	52	32
30	Ice and rain protection	77	67
31	Indicating/recording systems	30	25
32	Landing gear	965	209
33	Lights	1239	613
34	Navigation	378	285
35	Oxygen	73	28
36	Pneumatics	30	27
38	Vacuum	68	60
39	Electrical - Electronic Panels and Multipurpose Component	1	1
45	Onboard Maintenance Systems	1	1
46	Information Systems	2	2
49	Airborne auxiliary power	199	107
51	Standard practices and structures	6	2
52	Doors	113	104
53	Fuselage	8	1
56	Windows	26	22
57	Wings	3	2
71	Power plant	28	22
72	Engines	46	38

Continuation of table 1.6

73	Engine fuel and control	52	34
74	Engine ignition	12	5
75	Engine air	22	10
76	Engine controls	18	13
77	Engine indicating	29	24
78	Engine exhaust	21	13
79	Engine oil	37	25
80	Starting	40	29
Cumulative failures for the stated interval		4921	7143

The failure information alongside flight hour data was used to determine T_{Σ} , λ_{Σ} and K_{1000} for each of the aircraft fleet; the results are as shown in the table 1.7.

Table 1.7

Results of numerical reliability analysis of aircraft fleet in Nigeria

Aircraft		Flight hours	n_T	T_{Σ}	λ_{Σ}	K_{1000}
Helicopters	S-76	29116	1676	17.37	0.06	58
	S-92	12991	712	18.25	0.06	55
Aeroplanes	MD-83	16006	7143	2.24	0.45	446
	ERJ-135	4492	716	6.27	0.16	159
	ATR 42-300	4755	359	18.79	0.08	76

The charts in Fig 1.10-1.14 pictorially illustrate the topmost failing ATA chapter in flight for all the examined fleets.

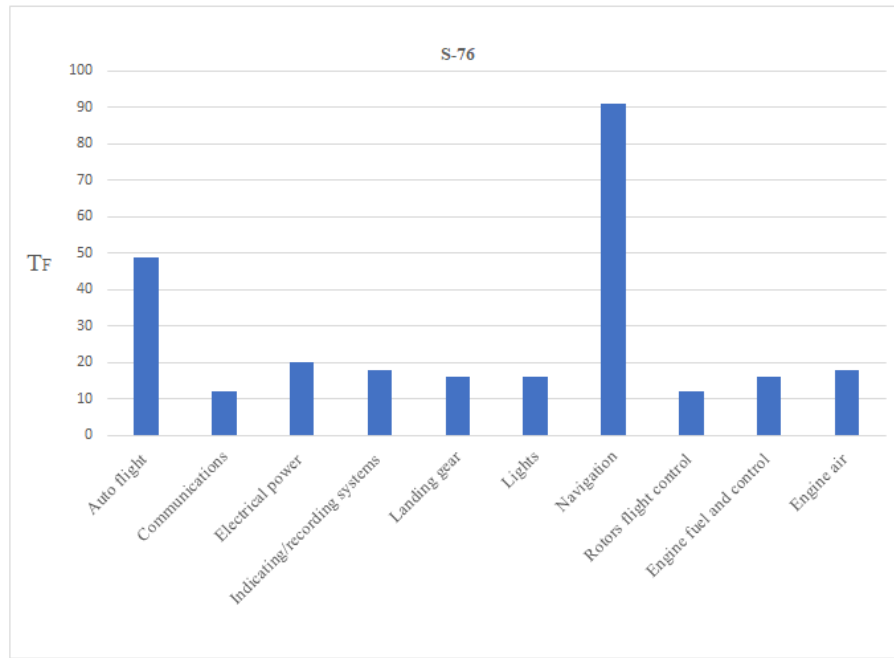

Fig. 1.10. Topmost failing ATA chapters in flight for S-76.

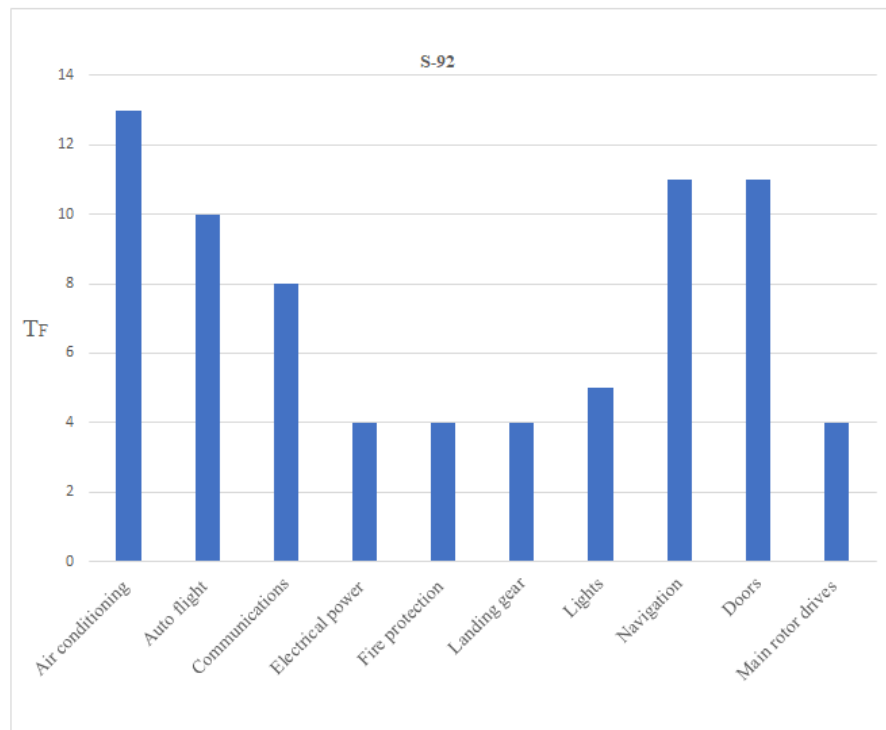

Fig. 1.11. Topmost failing ATA chapters in flight for S-92.

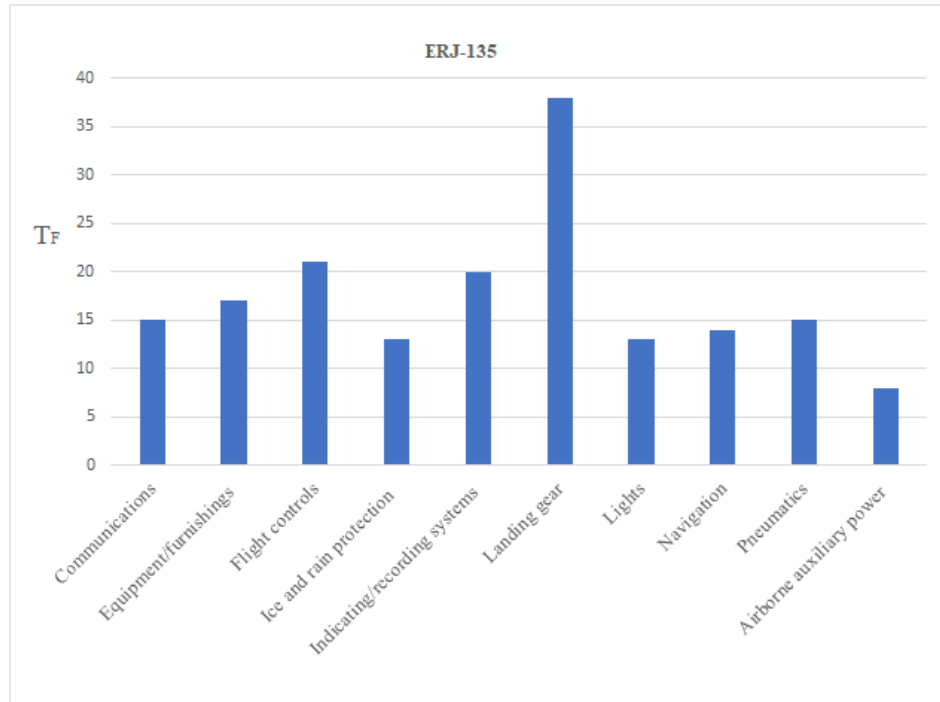

Fig. 1.12. Topmost failing ATA chapter in flight for ERJ-135.

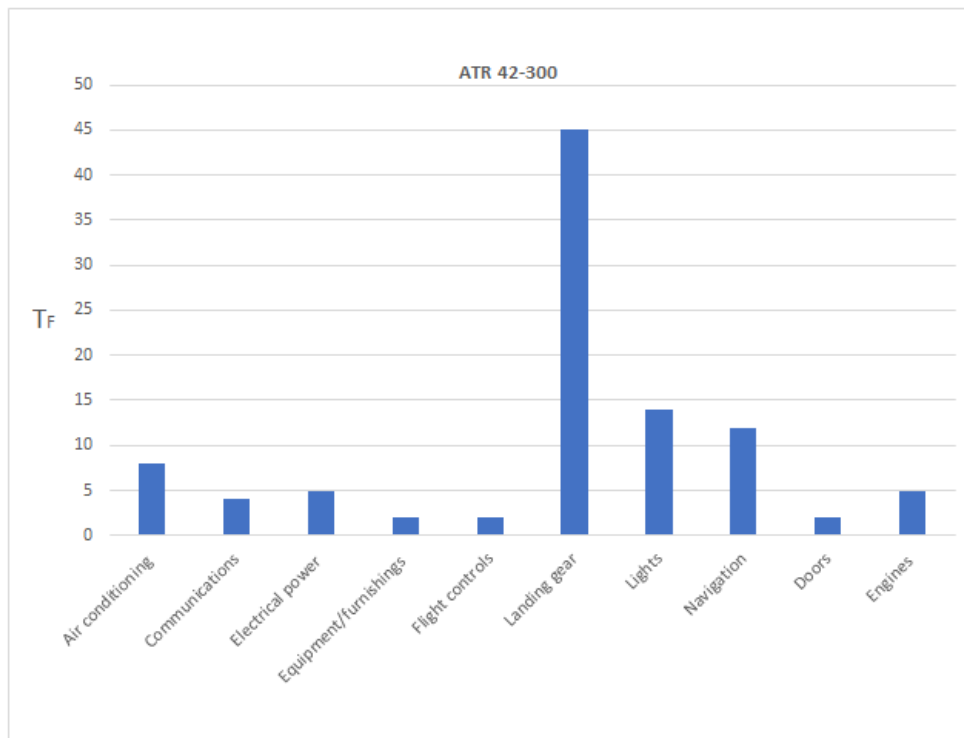

Fig. 1.13. Topmost failing ATA chapter in flight for ATR 42-300.

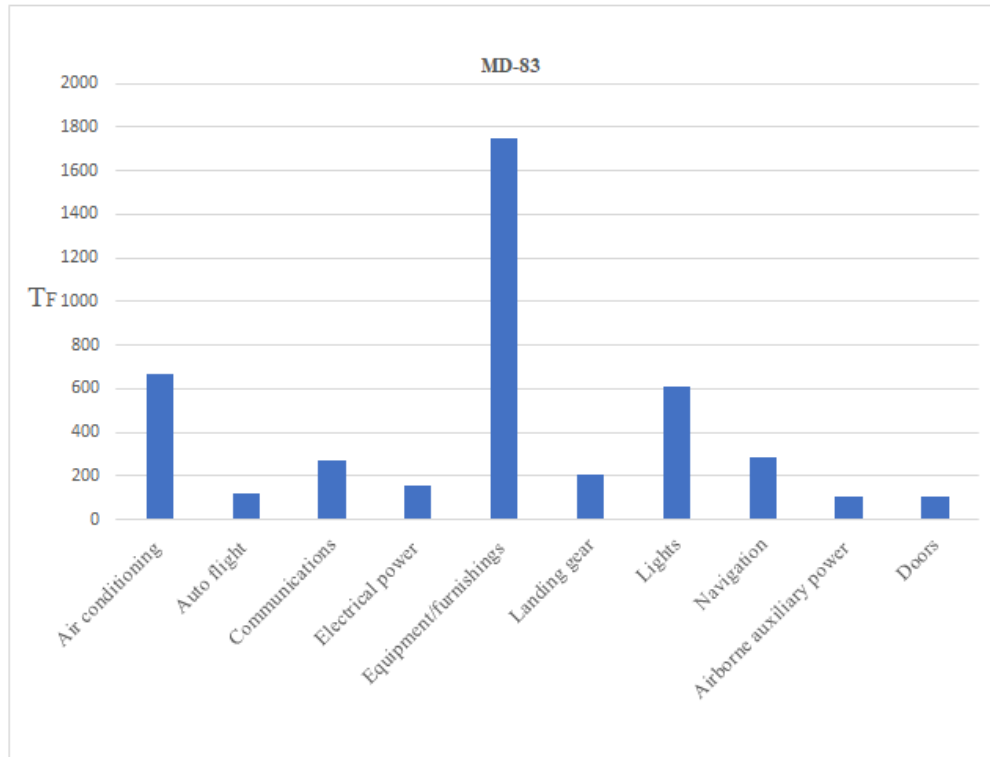

Fig. 1.14. Topmost failing ATA chapter in flight for MD-83.

For the S-76 helicopters (Fig. 1.10), the aircraft systems and structures with the lowest reliability levels are the auto flight, communications, electrical power, indicating/recording systems, landing gear, lights, navigation, rotors flight control, engine fuel and control, and engine air.

For the S-92 helicopters (Fig. 1.11), the aircraft systems and structures with the lowest reliability levels are the air conditioning, auto flight, communications, electrical power, fire protection, landing gear, lights, navigation, doors and main rotor drives.

For the ERJ-135 aeroplanes (Fig. 1.12), the aircraft systems and structures with the lowest reliability levels are the communications, equipment/furnishings, flight controls, ice and rain protection, indicating/recording systems, landing gear, lights, navigation, pneumatics and airborne auxiliary power.

For the ATR 42-300 aeroplanes (Fig. 1.13), the aircraft systems and structures with the lowest reliability levels are the air conditioning, communications, electrical power, equipment/furnishings, flight controls, landing gear, lights, navigation, doors and engines.

For the MD-83 aeroplanes (Fig. 1.14), the aircraft systems and structures with the lowest reliability levels are the air conditioning, auto flight, communications, electrical power, equipment/furnishings, landing gear, lights, navigation, airborne auxiliary power, and doors.

1.3.3 Analysis of results of numerical reliability indicators using the bathtub curve

The bathtub curve (fig. 1.15) is a well-known concept used to represent failure behavior of engineering items because the failure rate of such items is a function of time (i.e., it changes with time).

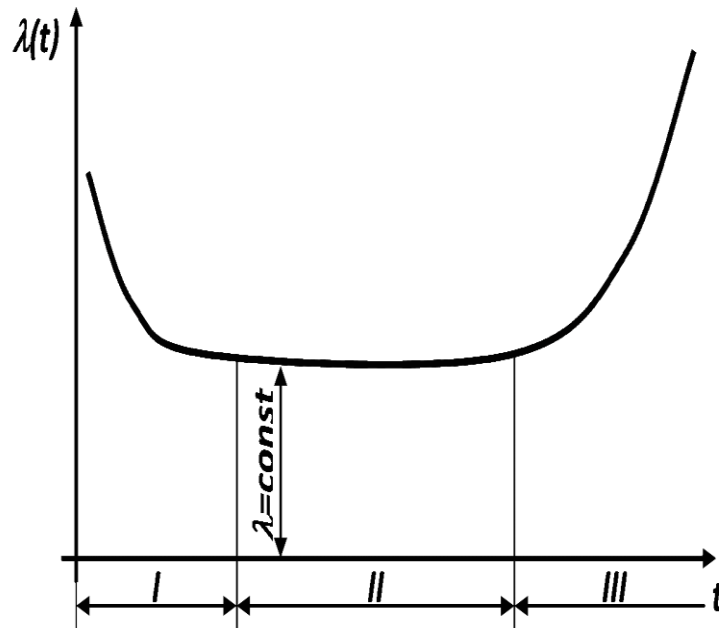

Fig 1.15. Bathtub curve for representing failure behavior of engineering items [94]

A bathtub curve is shown in the figure above and is divided into three regions. Region I is known as the burn-in region, debugging region, infant mortality region, or break-in region. During this period, the time-dependent failure rate decreases because of failures occurring for reasons such as poor manufacturing methods, Substandard materials and workmanship, poor quality control, poor processes poor debugging, and human error. Region II is referred to as the “useful life period,” during which the failure rate remains constant. Some of the reasons for the occurrence of failure in this region are undetectable defects, human errors, higher random stress than expected and natural failures. Region III is known as the “wear-out period,” during which the failure rate increases because of reasons such as wear caused by friction and aging, incorrect overhaul practices, poor maintenance, corrosion, and creep [19, 29, 95].

The dynamics of the inflight failure rate of the systems and structures of the helicopters is shown in Fig. 1.16. The transition period from the normal operation phase (2014 – 2015) to the third operational phase is clearly traced; the stage of increased wear of helicopter component parts, where the failure rate increases (2016 - 2018).

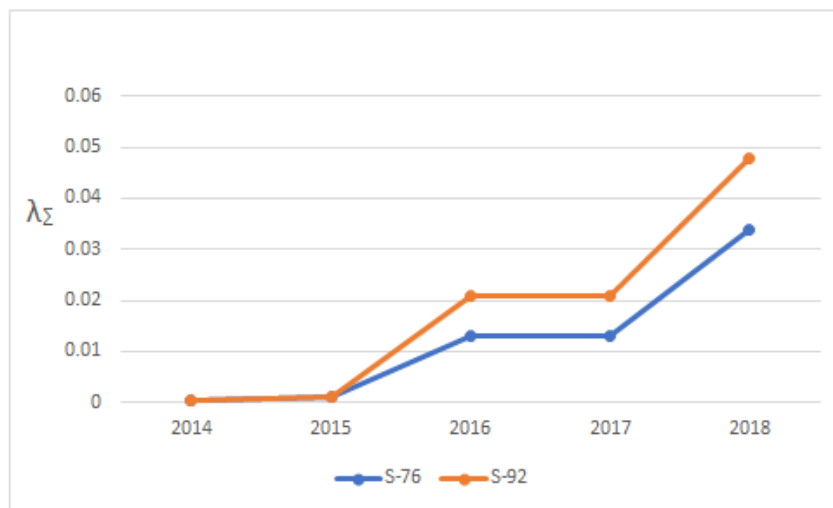

Fig. 1.16. Dynamics of λ_{Σ} for the helicopters.

The dynamics of the inflight failure rate of the systems and structures of the aeroplanes is shown in Fig. 1.17. The ATR 42-300 aircraft are in the useful life period of bathtub curve.

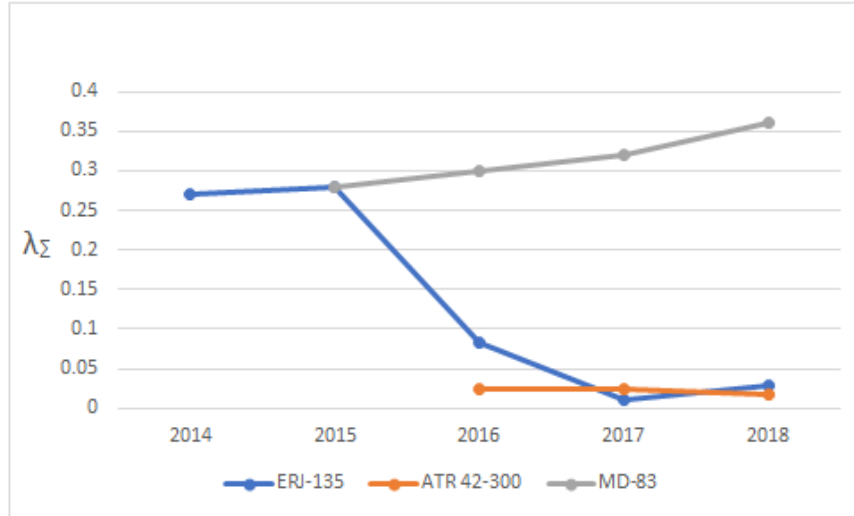

Fig. 1.17. Dynamics of λ_{Σ} for the aeroplanes.

For the ERJ–135 fleet manufactured in 1999, the initial decrease (2015 – 2017) in failure rate can be linked to major repairs carried out before its first flight in 2015 by the current operator. The MD-83 in the third stage of the bathtub curve characterized by increased wear hence they are considered an “aging” fleet.

CONCLUSIONS

1. An overview of aircraft maintenance in Nigeria is given as follows:
 - Various aircraft types are in operation in Nigeria and the commercial helicopter sector contributes to the economy by providing search and rescue services, and transportation to the offshore oil and gas industry;

- The NCAA is the only aviation regulatory authority in Nigeria; Part 5 of the NigCARs presents regulatory requirements for the continuing airworthiness of aircraft expected to operate in Nigeria in line with the SARPs in ICAO Annexes 6 and 8;
- ICAO Part M represents a compulsory operating license for aircraft operators and contains the minimum requirements for maintenance and airworthiness;
- The MRBR forms the basis for the maintenance program which is part of the approved maintenance system and must be monitored by qualified engineers for suitability at least annually;
- Operators in Nigeria typically follow either the MSG-2 or MSG-3 philosophy of aircraft maintenance.

2. Aircraft maintenance optimization is a multi-objective solution which aims to maximize revenue by maintaining high availability while simultaneously minimizing cost. Many researchers have suggested and tested a range of techniques based on aspects of aircraft maintenance processes such as planning, scheduling, maintenance task allocation, aircraft maintenance routing, spare parts inventory, personnel, and skill management, use of aircraft prognostics and health management data, and reliability models. An in-depth analysis of these models present the following findings:

- Insufficient attention is being paid to the use of reliability theory models, machine learning, predictive analytics, regression models and, probability and statistics theories for optimizing aircraft maintenance. These industry 4.0 concepts form a framework for data-driven predictive aircraft maintenance which will in the nearest future be the basis for carrying out aircraft maintenance tasks.
- Insufficient attention is being paid to understanding the interaction between reliability levels and historical trends of faults and failures. This is especially important because systems and components may have inherent failures and their reliability may vary based on previous scheduled checks and repairs. Furthermore, an in-depth understanding of this interaction will significantly improve the design, manufacturing, and operation of aircraft.

- Little or no scientific research is being carried out to find solutions to the problem of significantly higher than normal aircraft maintenance cost in Nigeria and the West African region for continuing airworthiness.

3. A good place to begin this study devoted to the optimization of aircraft maintenance processes for continuing airworthiness of aircraft in Nigeria to carry out a simple numerical reliability analysis using daily aircraft operations data. This analysis revealed the following insights:

- The least reliability aircraft systems or structure for each of the fleet analyzed
- The dynamics of failure rate of each aircraft fleet and where it lies in the bathtub curve.

CHAPTER 2: MATHEMATICAL MODELLING FOR THE OPTIMIZATION OF AIRCRAFT MAINTENANCE PROCESSES FOR CONTINUING AIRWORTHINESS

As shown in chapter 1, maintenance accounts for 10-20% of aircraft operations cost. This figure is significantly higher in the West African region with Nigeria being the highest and hence the need for aircraft maintenance optimization models. Furthermore, a review of literature related to aircraft maintenance optimization shows a lack of models based on reliability theory, predictive analytics, regression, machine learning, probability, and statistics theory. This chapter explores the development of aircraft maintenance optimization models and algorithms based on the principles of these theories and their validity. As stated in chapter 1, the term ‘failure’ refers to faults and failures of aircraft components, subsystems, systems, or structures.

2.1 Use of daily aircraft operations data for statistical data processing algorithms

An aircraft typically comprises of million parts that are collected globally and assembled in an extremely complex process. Its’ life cycle consists of four phases – The first phase is for design and development which consists of planning and conceptual design, preliminary design and system integration, detailed design. The second phase is the production and/or manufacturing stage. The third phase is for operation, and the final stage is disposal. The longest phase is the operation stage and generates most of the statistical data in the aircraft life cycle. In the operational phase of the avionics and flight control systems alone, the aircraft generates a wealth of real-time data, which is collected, transferred, and processed with 70 miles of wire and 18 million lines of code [12-13].

Recent research highlights that statistical data processing algorithms can be related to intelligence-based information technologies can be implemented to improve efficiency [6-10];

Statistical data processing algorithms can be used to improve the efficiency of aircraft operations given diagnostic variables and reliability parameters as initial data [11]. In general, the trends of these variables and parameters are non-stationary random processes [97]. The trends contain quasi-stationary intervals for the period of normal operation of aircraft components and systems. During the deterioration phase of aircraft systems, there are changes to statistical characteristics of observed trends. Such changes can occur due to different reasons: personnel errors, aging of components and systems, etc. [98-100]. Statistical data processing algorithms based on the principles of artificial intelligence estimate the time of possible failure with the aim of preventing it based on correct and timely operational action [101]. To implement these principles, the operational system (OS) can be used. The structural diagram of the operational system of an aircraft using artificial intelligence-based principles is presented in Fig. 2.1.

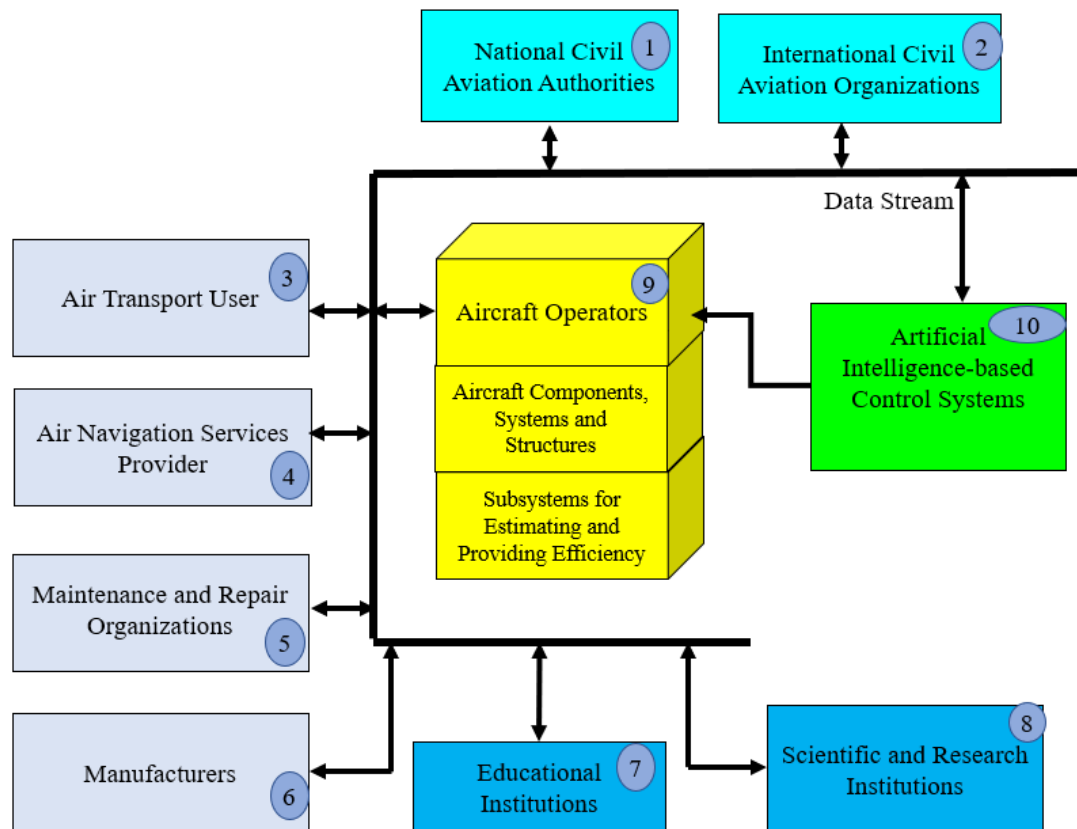

Fig. 2.1 Structural diagram of the operational system of an aircraft

According to Fig. 2.1, the OS of an aircraft is an organization of systems that includes equipment, facilities, organizational structure, processes, personnel, documentation, resources, information technologies etc. Units 1 and 2 are international and national regulators, unit 3 is for the passengers and cargo. Unit 4 is a key component of flight safety, units 5 – 9 determine and maintain the reliability levels and efficiency of aircraft systems. Unit 10 provides an adaptive control of operation under conditions of prior uncertainty [102-104]. The OS of an aircraft contains subsystems, which evaluate the quality of maintenance and operations. The results of this evaluation are used to generate and implement predictive and preventive maintenance actions. In addition, the OS is based on artificial intelligence principles, which allow for the processing of big data streams. This creates an organizational structure that provides required levels of flight safety, reliability, and aircraft availability.

The data generated by the operations phase of aircraft life cycle can be used to develop the following data processing algorithms:

- Algorithms for the development of mathematical models.
- Algorithms for the optimization of aircraft maintenance task intervals.
- Regression analysis.
- Detection algorithms.
- Estimation algorithms.
- Diagnostics.
- Adaptive monitoring.
- Heteroscedasticity analysis.
- Correlation analysis.
- Heuristic algorithms.
- Prognostics [105]

This study focuses on developing models and algorithms based on these principles using daily operations aircraft data of various fleet in Nigeria shown in Chapter one.

An overview of models

The initial step for studying a system is to formulate a model from which predictions concerning the system's behaviors can be made; building a model involves formulating the objective function which is a mathematical function of the decision variable [106]. According to [107] and [108], three types of models exist:

- 1) Iconic models which visually represent some aspects of a system.
- 2) Analog models which use one set of properties to represent another set of properties possessed by the system being studied.
- 3) Abstract models which require mathematical or logical operations to formulate a solution to the problem.

For the context of this study, models mean an abstraction of Aircraft Components, Subsystems Systems and Structures (ACSSS) that can provide a framework for the optimization of aircraft maintenance processes.

This study proposes models based on analytical, numerical and simulation methods which are data-driven and can be scaled to other systems. More precisely, the use of stochastic computer simulation often referred to as Monte Carlo simulation (MCS) is employed throughout the study. Computer simulation serves as an important tool in the optimization of maintenance activities; recent advances in simulation methodology and stochastic optimization have combined to make simulation one of the widely accepted tools in system analysis and operation research [105]. MCS is one of the three reliability predicting methods widely used in the aviation industry – the other two are: a) Markov chain modeling method, and b) Classic fault tree analysis and reliability block diagram combined methods. MCS is a mathematical technique for modelling phenomena with significant uncertainty. It is performed based on random samples of hazard intensities – Introducing randomness in a system can help solve optimization problems. In quantitative analysis and decision making, MCS provides an effective means to account for risk through models of a range of value sampling from probability distributions [19].

Optimization is a mathematical process; maintenance risks can be evaluated by probabilistic analysis methods, because in addition to design variables, operational environments and damage characteristics are probabilistic in nature. Uncertainties exist in all phases of the aircraft life cycle - probabilistic analysis practically addresses all malfunction cases instead of considering them in the worst-case scenarios. Therefore, with sufficient design and available data, maintenance plans can be optimized resulting in cost reduction while maintaining an acceptable risk level [109]. To assess the overall reliability performance of aircraft systems, Monte Carlo-based techniques are proposed in this study to evaluate performance of system using probability distribution of reliability indices. The proposed mathematical models are based on probability theory and statistics, reliability theory, predictive analytics, machine learning, and regression models for the optimization of aircraft maintenance processes for continuing airworthiness of aircraft in Nigeria. This chapter introduces statistical, probabilistic and regression approaches which are beyond the scope of experience of MSG-2 and MSG-3. These approaches are data driven and are reliable in determining optimized intervals for aircraft maintenance actions.

2.3 Algorithms and models for reliability analysis of aircraft components, subsystems, systems, and structures

Reliability centered maintenance (RCM) plans for future maintenance based on the current technical state of a system. It is defined as “methods to identify and select failure management policies to achieve the required safety, availability, and economy of operation efficiently and effectively” [28]. This is carried out based on a) statistical and reliability calculations of the system’s operation and b) Basic components of PM, repair, and removal actions. RCM provides information for planning PM and PdM actions thereby reducing operational cost.

Reliability is generally measured by a failure probability and optimization ensures that the latter remains lower than the given threshold [110]. Over the last two decades, reliability

analysis methods have been developed – these have stimulated interest for probabilistic treatment of structures [109]. Reliability analysis involves the evaluation of the level of safety of a system. Given a probabilistic model (an n -dimensional random vector \mathbf{X} with probability density function $f_{\mathbf{X}}$) and a performance model (a function \mathbf{g}), it uses mathematical techniques to estimate the system safety level in the form of a failure probability [111]. The MCS technique makes use of the numerical simulation of the performance function through the probabilistic model. Failure is generally defined as an event $F = \{\mathbf{g}(\mathbf{X}) \leq 0\}$ and the probability of failure is defined as:

$$p_f \equiv \mathbb{P}(\{\mathbf{g}(\mathbf{X}) \leq 0\}) = \int_{D_f = \{\mathbf{x} \in \mathbb{R}^n: \mathbf{g}(\mathbf{x}) \leq 0\}} f_{\mathbf{x}}(\mathbf{x}) d\mathbf{x} \quad (2.1)$$

Engineering problems generally involve uncertainties. Therefore, reliability methods provide powerful tools for handling these uncertainties based on the performance function or limit state function [112].

A review of literature shows significant research in the development of models for RCM strategies but there is a gap in mathematical models to determine characteristic reliability of aircraft systems for optimizing aircraft maintenance. The authors in [97] developed a reliability model which can increase efficiency of electronic components of wind generators in the Black Sea region. Data was collected during wind turbine operation and the obtained results can be used to improve the efficiency of wind generators. Their work highlighted the feasibility of developing reliability models for other complex systems and the insight gleaned is applied to the modelling approach presented in this study. Furthermore, the numerical reliability analysis carried out in chapter 1 was not tested for goodness of fit because it was based on simple formulars and therefore contains errors. Therefore, statistical simulation reliability analysis models are developed in the subsections that follows.

2.3.1. Statistical simulation models for aircraft reliability analysis

Many mathematical definitions and probability distributions are used to perform different types of maintenance, and reliability studies. Weibull distribution is typically used to model fatigue or wear out. However, during the operational phase of any component, subsystem or system, the most common probability distribution used is the exponential distribution because it is easily applied in various types of analysis of failure rates during useful life. The probability of failure-free operation and steady state availability for exponential distribution is calculated as follows [29]:

$$R(t) = e^{-\lambda t}, \quad (2.2)$$

$$A = \frac{MTBF}{MTBF+MTTR} = \frac{\mu}{\lambda+\mu}, \quad (2.3)$$

$$MTBF = \frac{1}{\lambda}, \quad (2.4)$$

$$MTTR = \frac{1}{\mu}, \quad (2.5)$$

$$MTBF = \int_0^{\infty} R(t)dt, \quad (2.6)$$

where R – reliability at time t ; λ – failure rate; A – steady state availability; μ – repair rate.

The exponential distribution probability density function is defined by

$$f(t) = \lambda e^{-\lambda t} \text{ for } t \geq 0 \lambda > 0 \quad (2.7)$$

where t is time, $f(t)$ is the Probability Density Function (PDF) and λ is the distribution parameter, which in reliability studies refers to the constant failure rate [29]. Cumulative Distribution Function (CDF) is expressed by

$$F(t) = \int_{-\infty}^t f(y) dy \quad (2.8)$$

By substituting equation (7) into (8) we get the expression for the exponential distribution CDF

$$F(t) = \int_0^t \lambda e^{-\lambda y} dy = 1 - e^{-\lambda t} \quad (2.9)$$

Considering that the most used probability distribution for mean time between failures is the exponential distribution, this study proposes an exponential distribution of failures of ACSSS for calculating reliability indices. For the proposed model, the ACSSS were categorized in accordance with the ATA Spec 100 numbering system. Input data n_T is extracted from pilot and maintenance reports of a fleet of aircraft in Nigeria – these are shown in Chapter 1. The following reliability indices are determined for each ATA chapter using PDFs:

- Failure rate λ
- Mean time between failure (*MTBF*)
- Number of failures per 1000 flight hours (K_{1000})

The nomenclature for the parameters is shown in Fig. 2.2

Nomenclature for the parameters and variables used in the simulation

- A*: matrix of n_T
- a*: additional variable for calculation
- i*: index of initial matrix
- j*: additional index of matrix
- k*: index of matrix obtained during simulation
- p*: index of final matrix
- m*: number of aircraft ATA chapters observed
- s*: additional variable for calculation
- t*: mean time between failure
- x*: value of random variable
- B_i*: cumulative number of observed failures in time
- C*: random numbers of exponential distribution of N and λ
- D_k*: time series of observed failures
- E_k*: random number with uniform distribution in the range 0...1
- F_{i,k}*: time moment *i*-th system failure occurs
- M*: total of observed failures for all aircraft ATA chapters
- N*: number of iterations
- T*: cumulative flight hours for the observed interval
- λ : failure rate

Fig. 2.2 Nomenclature for parameters and variables for reliability analysis

The input data n_T is an $m \times 1$ matrix A . Function B is formulated to decide on which ATA chapter failed. The $B_{i+1} - B_i$ value corresponds to the probability of i -th component failure. The function B_i is referred to as the graph of monitoring data (Fig. 2.3) and is used to visually analyze how the failures occur.

$$B_i = \frac{\sum_{j=0}^i A_j}{M}; \quad M = \sum_{i=0}^m A_i, \quad i = \{0 \dots m\} \quad (2.10)$$

The Time Between the Failures (TBF) is described by an exponential distribution with parameter λ and it is assumed that only one failure can occur at a time. To determine which ATA chapter failed, calculation of the specific number of failures per component, subsystem, system, or structure is carried out. MCS is applied to generate random numbers with sample size $N=10000$ – these numbers have a uniform distribution in the range $[0; 1]$.

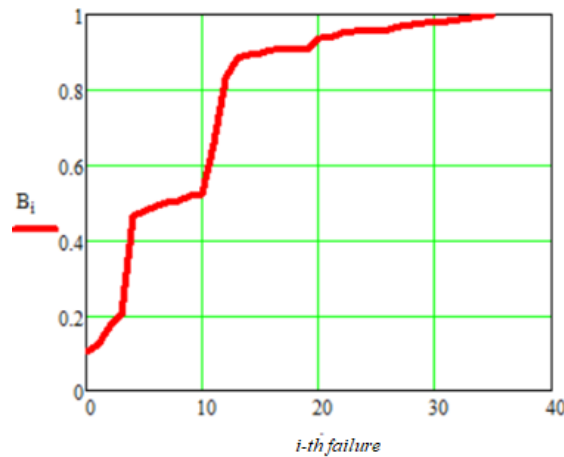

Fig. 2.3 Graph of monitoring data

The next step is computing the time series of observed failures D_k

$$D_k = \sum_{j=0}^k C_j \quad (2.11)$$

where C_j is the exponential distribution of N and λ . The time moment F at which the i -th failure occurs is defined as follows

$$F_{0,k} = \begin{cases} D_k & \text{if } E_k \leq 0 \\ 0, & \text{otherwise} \end{cases} ; \quad F_{i,k} = \begin{cases} D_k & \text{if } B_{i-1} < E_k \leq B_i \\ 0, & \text{otherwise} \end{cases} \quad (2.12)$$

The output F is a two-dimensional array that cannot be used for plotting the PDFs needed for calculating the reliability parameters. Therefore, A_i is formulated

$$A_i = \begin{cases} s \leftarrow 0 \text{ for } k \in 0..N-1 \\ \text{if } F_{i-1,k} \neq 0, a_s \leftarrow F_{i-1,k} \\ s \leftarrow s + 1 \end{cases} \quad (2.13)$$

The resulting PDFs for are plotted and further analyzed for reliability parameters – λ_i , $MTBF_i$ and K_{1000} . The flowchart for the statistical simulation is given in Fig. 2.4.

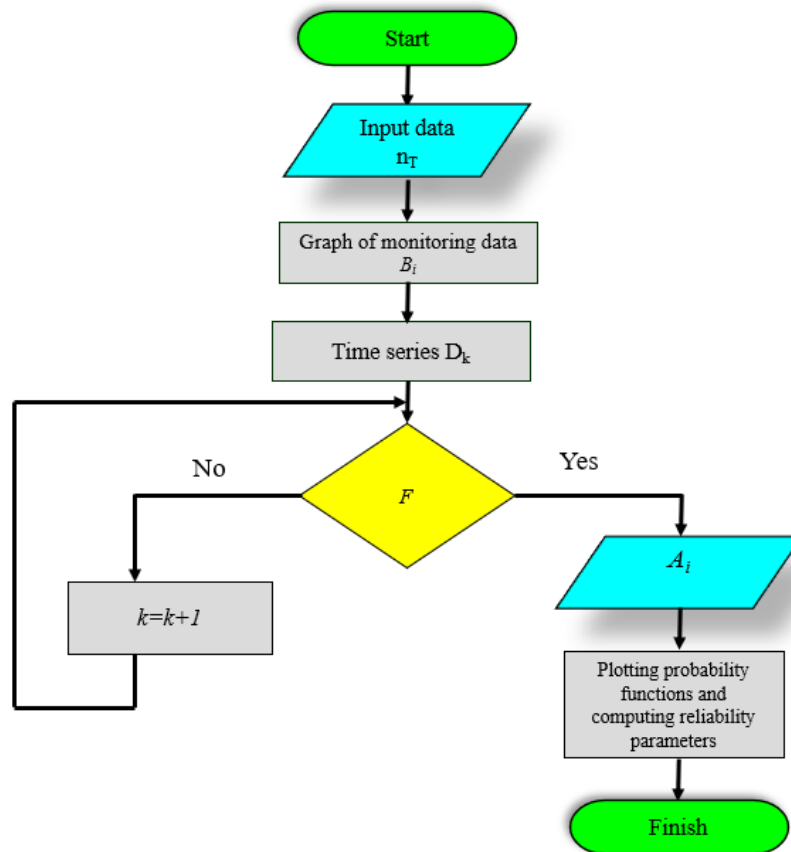

Fig. 2. 4 Flowchart for the statistical simulation modelling for reliability analysis

Goodness-of-fit test.

The proposed model is based on assumption and to check for accuracy, the goodness-of-fit test is applied to them to verify if it obeys the exponential distribution. The χ^2 -test was chosen to test the goodness of fit using one of the obtained PDFs. The calculated χ^2 should be less than the threshold value $\chi_{th}^2 = 19.675$. If this is followed, the hypothesis for the exponential distribution law of mean time to failure of ACSSS is accepted with the corresponding significance level equal. Furthermore, the theoretical exponential distribution is given as:

$$f(t) = \lambda_{calc} e^{-\lambda_{calc} t} \phi(t) \quad (2.14)$$

where λ_{calc} is the failure rate calculated based on the resulting PDF, $\phi(t)$ is the Heaviside function.

The limitation of this model based on the χ^2 - test is that it is only suitable for a minimum sample size of 35. Therefore, a model for aircraft operations which generate a small dataset is proposed in the next section.

2.3.2. Statistical simulation model for reliability analysis given a small dataset

A small dataset reduces statistical significance and poses limitations [113] thereby making it difficult to reach any general conclusions [114]. A small dataset causes the estimation performance of a developed model to be poor. When there are many independent variables, a model becomes complicated, and a small dataset further invalidates the estimation method. At high total flight hours, small datasets produce large confidence intervals which imply lower statistical reliability – a key disadvantage of using a small dataset is the lack of statistical stability [115-116]. In specific cases of testing predictive models, small datasets are tougher because they are not offset with large effect sizes, and they undermine accurate tests with predictive models [117].

For small dataset the model selected by the Akaike information criterion appears to be anti-conservative even with regards to the maximum Type I error rate of the maximal model

[118]. A possible solution to the small dataset problem is the use of pre-trained networks also referred to as transfer learning. This is achieved by initializing the neural network with the weights trained in the related domains and finetuning the model with in-domain data. This approach speeds up training and has gained popularity in various industries for handling the lack of significant samples in a dataset [119]. Additionally, exact non-parametric tests can be used to overcome problems associated with small datasets in hypothesis testing. The p-values in nonparametric tests calculate the exact probability of obtaining observed or extreme results under the null hypothesis [120]. Deep convolutional neural networks can be used to fit small datasets with simple and proper modification without the need to redesign specific small network [121]. Proportion distribution of outliers and small dataset narrow the performance difference between models in a test set, because the advantages and disadvantages of the model are not fully discovered [122]. In the case of the small dataset with the existing outliers, [123] proposed a generalized mean distance-based K-nearest neighbor by introducing multi-generalized mean distances and the nested generalized mean distance which are based on the characteristic of the generalized mean.

In comparison to conventional analysis, Bayesian approach to inference has an advantage of handling uncertainty for small dataset in aircraft fleet-wide prognostics [124]. The Bayesian Markov chain Monte Carlo approach allows for accurate reliability evaluation using a numerical simulation method given non-informative prior information but only works when the sample size is at least ten [125]. A combination of variable importance in projection analysis method and regression models can be used to tackle the problem of small dataset studies of cost estimation for general aviation aircraft [126]. Decoding performance is shown by how much classification results depart from the rate obtained by purely random classification. In a 2-class or 4-class classification problem, the chance levels are 50% or 25% respectively but these thresholds do not hold for small dataset [127].

The proposed model for small dataset calculates the failure rate based on the probability of failure-free operations. The input data is a continuous statistical data x_i with sample size n

extracted from preprocessed pilot and maintenance reports of failures for the observed interval. The steps for finding the probability of failure-free operation is as follows:

Step 1 Determine the number of observations for tails approximation $j=1.5\sqrt[3]{x}$. For the approximation, Chauvenet's criterion is used with transformation of the following type

$$Q_i = Med.F^{K_i V} \quad (2.15)$$

where Q_i is an approximated variable, Med is the median value of the sample, F is the basis function, K_i is a quantile of normal distribution with zero expectation and standard deviation of 1, V is the variation coefficient $V = \frac{stdev(x)}{mean(x)}$

Step 2 To obtain the values of the lower ($y_{i \text{ lower}}$) and upper tail ($y_{i \text{ upper}}$), the transformed sample (order) is obtained as follows:

$$y_i = \ln \frac{x_i^{(order)}}{Med} \quad (2.16)$$

where $x_i^{(order)}$ is the order statistics for input data x_i .

Step 3 Calculate the sums of first (δ_1) and last (δ_2) random variables using the transformed order statistic is given as

$$\delta_1 = \sum_{i=1}^j y_i; \quad \delta_2 = \sum_{i=n-j}^n y_i \quad (2.17)$$

where j depends on the sample size

Step 4 Corresponding quantiles of the standard normal distribution after the transformation are calculated according to Kazakyavicius equation

$$K_i = 2.0637 \left(\ln \left(\frac{1}{1-p_i} \right) - 0.16 \right)^{0.4274} \quad (2.18)$$

where p_i is the empirical probabilities of each observation of order statistic $p_i = \frac{i}{n}$, $i = 0 \dots n$

Step 5 The products of the variation coefficient and the sum of corresponding quantiles is calculated as follows

$$\delta_{K \min} = V \sum_{i=1}^j K_i; \quad \delta_{K \max} = V \sum_{i=n-j}^n K_i \quad (2.19)$$

Step 6 The transformation basis for the minimum (β_1) and maximum (β_2) are determined using

$$\beta_1 = e^{\frac{\delta_1}{\delta_{K \min}}}; \quad \beta_2 = e^{\frac{\delta_2}{\delta_{K \max}}} \quad (2.20)$$

Step 7 Calculation of the basis function F using the following formulas

$$F_1(K_i) = \frac{\beta_1 e^{-K_i} + \beta_2 e^{K_i}}{e^{-K_i} + e^{K_i}}, \quad (2.21)$$

$$F_2(K_i) = \beta_1 + b(K_i + K_{sw})_+ - b(K_i - K_{sw})_+, \quad (2.22)$$

$$(K_i - K_{sw})_+ = \begin{cases} 0, & \text{if } K_i < K_{sw} \\ K_i - K_{sw} & \text{if } K_i \geq K_{sw} \end{cases} \quad (2.23)$$

where K_{sw} is quantile value that corresponds to the switching point, b is a coefficient determined by the formula

$$b = \frac{\beta_2 - \beta_1}{2K_{sw}} \quad (2.24)$$

Step 8 Computing the values of the variables Q_1 , Q_2 and Q_3 and plotting graphs

$$Q_1 = \text{Med. } F_1^{K_i V}$$

$$Q_2 = \text{Med. } F_2^{K_i V}$$

$$Q_3 = \text{mean}(x) \cdot K_i \cdot \text{stdev}(x)$$

Q_1 , Q_2 define the failures using the methodology for small dataset while Q_3 is in accordance with exponential distribution model proposed in 2.2.1 L_m which visually proves that L_m isn't accurate for small dataset.

Step 9 The graphs are used to visually check the goodness of fit of the proposed model

Application of the model

The resulting graph can be used to determine the probability that i number of failures will occur during the observed interval.

2.4 Mathematical models for the optimization of aircraft maintenance task intervals

Aircraft maintenance optimization refers to the development and analysis of mathematical models for improving maintenance policies. In recent years, significant research is being focused on the development of various maintenance optimization strategies. However, review of relevant literature shows that no study has proposed reliability models based on time between failures, observed time and repair cost to improve the efficiency of aircraft operations. This forms the basis for the development of mathematical models for the optimization of aircraft maintenance task intervals. These models quantify the cost and benefits of maintenance with the goal of obtaining an optimum balance between both. The limitation of this study is that only two failure models (exponential and Erlang models) were considered.

An optimal aircraft maintenance task interval is important because:

- As aircraft components and systems deteriorate, it is important to carry out maintenance actions and this results in an increase in operational cost. Therefore, there is the need for an optimal interval that balances the frequency of aircraft maintenance tasks and the failure rate.
- Maintenance decisions are based on results of the analysis of aircraft operational data.
- The proposed models in this section can be used to optimize aircraft operations.
- The proposed models can be considered as a part of artificial intelligence-based OS of an aircraft.

2.4.1 Methodology for the optimization of aircraft maintenance task interval.

Statistical simulation allows for the investigation of maintenance processes while considering various operational conditions. The steps for the optimization of maintenance task intervals of aircraft systems are outlined as follows:

1. Analysis of maintenance tasks of aircraft systems to identify parameters for the models.
2. Development of basic failure models and analysis of aircraft operational data.
3. Parameterization of models, setting the tolerance values of parameters.
4. Determining efficiency indicators for the maintenance of aircraft components, subsystem, systems, and structure
5. Defining one or more criteria to measure efficiency of optimized aircraft maintenance task interval.
6. Determining equations for evaluating the efficiency of optimized aircraft maintenance task intervals.
7. Computing equations for the optimization of aircraft maintenance task intervals, this means designing mathematical models for finding optimal values [128-131].

For this study, the key objective is the optimization of aircraft maintenance task intervals. The aircraft maintenance tasks considered are:

- Monitoring and control of the technical condition of aircraft systems.
- Adjusting and repairing component parts/systems to meet regulatory standards.

The efficiency indicators of aircraft components, subsystem and systems are defined as:

- Costs incurred by airlines due to failure of aircraft components, subsystem, and systems.
- Steady state availability of aircraft components, subsystem, and systems.
- Overall operational costs.
- Probability of failure-free operation of aircraft components, subsystem, and systems [132].

Selecting the PDF of the TBF is the initial step for mathematical modelling. Based on the PDF, the efficiency of the maintenance processes is calculated; the average operational cost per unit time is chosen as the efficiency indicator and it is calculated using the equation

$$E(C/T_M) = \frac{E(n/T_M)C_R + C_M}{T_M}, \quad (2.25)$$

where $E(n/T_M)$ is expected value of number of failures, C_R is CM cost, C_M is PM cost, T_M is the maintenance interval based on flight hours/cycles. exponential and Erlang mathematical models of TBF are further considered.

2.4.2 Mathematical modelling of exponential model of time between failures to determine an optimal aircraft maintenance task interval

The PDF of the exponential model of TBF is defined by

$$f(t) = \lambda e^{-\lambda t}, \lambda > 0, t > 0,$$

The number of failures is determined using a Poisson distribution

$$P(n/t) = \frac{(\lambda t)^n}{n!} e^{-\lambda t}.$$

The expected number of failures for the observed time interval T_M of the aircraft component, subsystem, or systems i defined by

$$E(n/T_M) = \lambda T_M$$

Equation (2.25) can be presented as

$$E(C/T_M) = \lambda C_R + \frac{C_M}{T_M}. \quad (2.26)$$

The dependence of equation (2.26) on T_M does not contain minimum values because

$$\frac{\partial E(C/T_M)}{\partial T_M} = -\frac{C_M}{T_M^2} \neq 0.$$

Therefore, for the exponential model of TBF, an optimized aircraft maintenance task interval is not feasible because optimal maintenance task interval tends to infinity.

2.4.3. Mathematical modelling of Erlang model of time between failures to determine an optimal aircraft maintenance task interval

The PDF of the Erlang model of TBF is defined by

$$f(t) = \lambda^2 t e^{-\lambda t}, \quad \lambda > 0, \quad t > 0$$

The PDF for the duration of n -th failure is

$$f_n(t) = \int_{-i\infty}^{i\infty} \left(\int_0^{\infty} \lambda^2 t e^{-\lambda t} e^{iwt} dt \right)^n dw. \quad (2.27)$$

Mathematical transformation of equation (2.27) gives the following result

$$f_n(t) = \frac{t^{2n-1}}{(2n-1)!} \lambda^{2n} e^{-\lambda t}.$$

The probability of occurrence of n failures during the observed time interval is defined by the CDF

$$F_n(t) = \int_0^t f_n(t) dt. \quad (2.28)$$

The distribution of number of failures can be calculated as

$$P(n/t) = F_n(t) - F_{n+1}(t) = \int_0^t f_n(t) dt - \int_0^t f_{n+1}(t) dt = \frac{(\lambda t)^{2n+1}}{(2n+1)!} e^{-\lambda t} + \frac{(\lambda t)^{2n}}{(2n)!} e^{-\lambda t}.$$

Therefore, the expected number of failures during the observed time interval T_M is expressed as

$$E(n/T_M) = \sum_{n=1}^{\infty} n P(n/T_M) = \sum_{n=1}^{\infty} \left(n \frac{(\lambda T_M)^{2n+1}}{(2n+1)!} + \frac{(\lambda T_M)^{2n}}{(2n)!} \right) e^{-\lambda T_M} = \frac{\lambda T_M}{2} + \frac{e^{-2\lambda T_M}}{4} - \frac{1}{4}.$$

The efficiency (2.26) can be presented as

$$E(C/T_M) = \frac{(2\lambda T_M + e^{-2\lambda T_M} - 1)C_R + 4C_M}{4T_M}. \quad (2.29)$$

Equation (2.29) is analyzed to find the minimum value by calculating the derivative

$$\frac{dE(n/T_M)}{dt} = \frac{-2\lambda C_R T_M e^{-2\lambda T_M} - C_R e^{-2\lambda T_M} + C_R - 4C_M}{T_M^2}.$$

The optimal aircraft maintenance task interval can be found by solving the equation

$$-2\lambda C_R T_M e^{-2\lambda T_M} - C_R e^{-2\lambda T_M} + C_R - 4C_M = 0. \quad (2.30)$$

In this case the approximate equation can be used

$$e^{-2\lambda T_M} \approx 1 - 2\lambda T_M$$

where,

$$-2\lambda C_R T_M + 4\lambda^2 C_R T_M^2 - C_R + 2\lambda C_R T_M + C_R - 4C_M = 0.$$

Therefore,

$$\lambda^2 C_R T_M^2 - C_M = 0.$$

The optimal maintenance task interval is defined as

$$T_{M\text{opt}} = \sqrt{\frac{C_M}{\lambda^2 C_R}} \quad (2.31)$$

Equation (2.31) is an approximate value. The exact equation for optimal aircraft maintenance interval can be obtained by solving equation (2.30) using Lambert function $W(x)$

$$T_{M\text{opt}} = \frac{-1 - W\left(\frac{4C_M}{C_R} - 1\right)}{2\lambda} \quad (2.32)$$

Therefore, for the Erlang model of TBF, an optimized aircraft maintenance task interval exists.

2.4.4 Methodology for determining an optimal aircraft maintenance task interval

In accordance with mathematical analysis of the exponential and Erlang model of TBF, the step-by-step procedure for optimizing maintenance task interval is as follows:

1. Calculation of the duration of n -th failure for any given PDF $f(t)$ TBF using the theory of functional transformation of random variables

$$f_n(t) = \int_{-i\infty}^{i\infty} \left(\int_0^{\infty} f(t) e^{iwt} dt \right)^n dw ;$$

2. Calculation of the probability $F_n(t)$ of n failures which occurred during the observed time interval using (2.28)
3. Determining the distribution of number of failures during the observed time interval

$$P(n/t) = F_n(t) - F_{n+1}(t);$$

4. Calculating the expected value of number of failures during observed time interval T_M

$$E(n/T_M) = \sum_{n=1}^{\infty} nP(n/T_M);$$

5. Analyzing the obtained equation for optimality i.e. finding the value of the optimal aircraft maintenance task interval.

The model development flowchart is presented in Fig. 2.5.

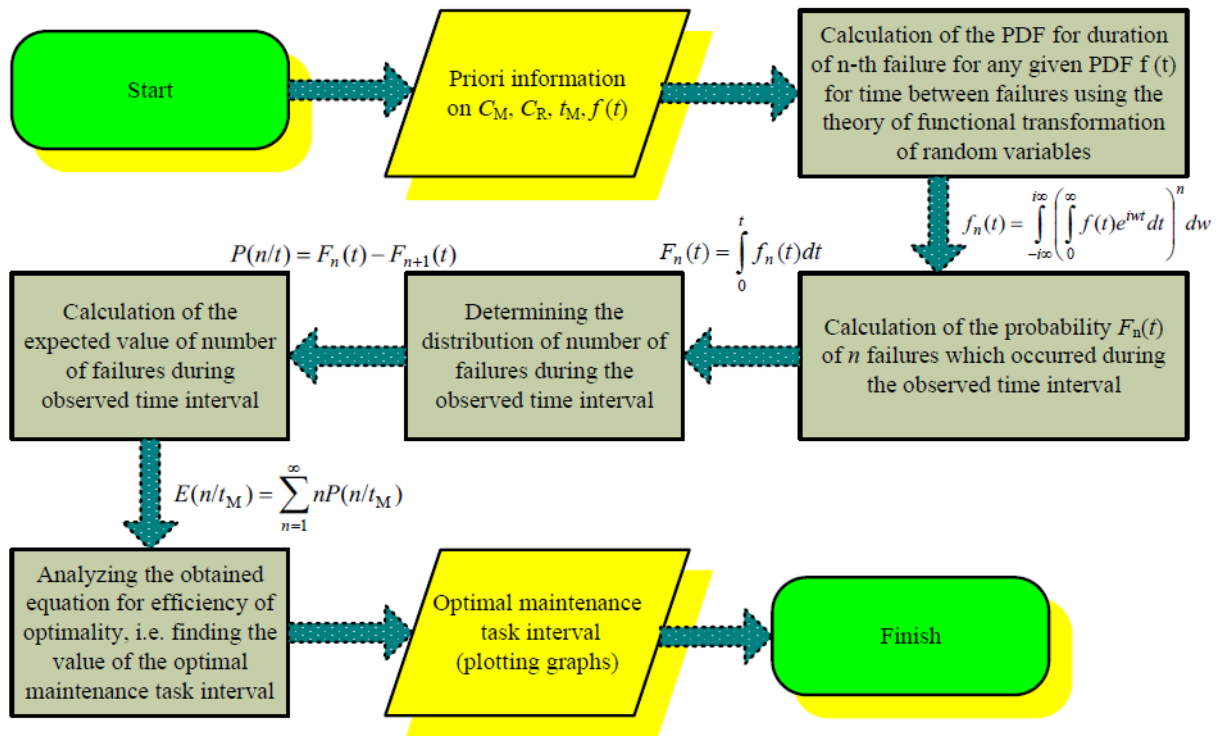

Fig. 2.5 Flowchart for finding an optimal aircraft maintenance task interval

2.5 Regression mathematical model for predicting the occurrence of aircraft component, subsystem, or system failures

Regression analysis is a simple predictive tool which investigates the relationship between independent and dependent variables [133]. Regression models are statistical models where we make a regression assumption [134]. They can be integrated to improve prediction accuracy of failures of aircraft components, subsystems, systems, and structures thereby providing valuable insights for aircraft maintenance planning. For the scope of this study, regression models are applied to predict the occurrence of failures during aircraft operations.

Regression analysis can also be viewed as a set of data analytic techniques that help understand the interrelationships among variables. The relationship is expressed in the form of a model or an equation which connects the dependent or response variable and one or more explanatory or predictor variables [135]. The dependent or response variable is denoted by y and is of particular interest. The independent, explanatory or regressor variables are used to predict the behaviors of Y and are denoted by X_1, X_2, \dots, X_k [136]. The relationship between y and x_i 's can be expressed via a function f

$$Y \approx f(X_1, X_2, \dots, X_k)$$

The relationship between the response variable Y and predictor variable X is given as a linear model

$$Y = \beta_0 + \beta_1 X + \varepsilon \quad (2.33)$$

where β_0 and β_1 are referred to as the model regression unknown coefficients and ε is a random disturbance or error. Equation (3.33) gives an acceptable approximation of the true relation between Y and X i.e. Y is an approximate linear function of X and ε measure the difference in that approximation. According to the observed sample, equation (3.33) can be written as

$$y_i = \beta_0 + \beta_1 x_i + \varepsilon_i \quad i = \{1, 2, \dots, n\} \quad (2.34)$$

where y_i represents the i th value of the response variable Y , x_i represents the i th value of the predictor variable X , and ε_i represents the error in the approximation of y_i .

2.5.1 Regression analysis models for optimizing aircraft maintenance

There are no predetermined coefficients for the regression analysis because calculations are based on aircraft operational data. Nomenclature for the parameters and variables used in the regression analysis are given as follows:

a: matrix of n

n: sample size

m: switching point

ϕ : Heaviside step function which is equal to 0 before the switching point and 1 after the switching point

T_i : time moment of failure

Y : predicted value i.e. optimal maintenance flight hour

X : i th number of failures, i

After the parameters are defined, the next step is determining which regression model is optimal for predicting the time moment of the next failure – for this purpose, three segmented (piecewise) models are tested. Segmented regression models are models where two or more lines are joined at unknown points called the switching points representing the threshold [137]. It partitions the data into different regions and a regression function is fitted to each one [135]. Segmented regression is an alternative variant of approximating empirical curves. Its use in aircraft operations will allow for increased correctness for the calculation of extreme probability values of occurrence of failures in ACSSS. The segmented regression models considered in this research are:

- Quadratic-linear segmented regression model
- Linear-linear segmented regression model
- Quadratic-quadratic segmented regression model

The matrix of unknown coefficients in the segmented regression models are estimated using the least square method. The vertical distances represent errors in the response and the least squares method gives the line that minimizes the sum of squares of vertical distances from each point to the line. These errors can be obtained by writing equation (34) as

$$\varepsilon_i = y_i - \beta_0 - \beta_1 x_i, \quad i=1, 2, \dots, n \quad (2.35)$$

The sum of squares of these distances can be written as

$$S(\beta_0, \beta_1) = \sum_{i=1}^n \varepsilon_i^2 = \sum_{i=1}^n (y_i - \beta_0 - \beta_1 x_i)^2$$

The values of $\widehat{\beta}_0$ and $\widehat{\beta}_1$ that minimize $S(\beta_0, \beta_1)$ are given as

$$\widehat{\beta}_1 = \frac{\sum (y_i - \bar{y})(x_i - \bar{x})}{\sum (x_i - \bar{x})^2}$$

and

$$\widehat{\beta}_0 = \bar{y} - \widehat{\beta}_1 \bar{x}$$

The estimates $\widehat{\beta}_0$ and $\widehat{\beta}_1$ are called the ordinary least squares estimates of β_0 and β_1 because they are the solution to the ordinary least squares method [135].

2.5.2 Quadratic-linear segmented regression model

The quadratic-linear segmented regression model for predicting the time moment of the next failure of an aircraft component, subsystem, system, or structure has the following form:

$$Y_1(X) = \beta_{0,1} + \beta_{1,1}X + \beta_{2,1}X^2 - \beta_{2,1}(X - m)^2\phi(X - m) \quad (2.36)$$

This model uses two segments joined together at the switching point m and three unknown coefficients $\beta_{0,1}$, $\beta_{1,1}$ and $\beta_{2,1}$. Using the ordinary least square method unknown coefficients are calculated as follows:

$$\begin{bmatrix} \beta_{0,1} \\ \beta_{1,1} \\ \beta_{2,1} \end{bmatrix} = \begin{bmatrix} n & \sum_{i=1}^n i & \sum_{i=1}^n i^2 - \sum_{i=m}^n (i-m)^2 \\ \sum_{i=1}^n i & \sum_{i=1}^n i^2 & \sum_{i=1}^n i^3 - \sum_{i=m}^n [(i-m)^2 i] \\ \sum_{i=1}^n i^2 - \sum_{i=m}^n (i-m)^2 & \sum_{i=1}^n i^3 - \sum_{i=m}^n [(i-m)^2 i] & \sum_{i=1}^n i^4 - 2 \sum_{i=m}^n [(i-m)^2 i^2] + \sum_{i=m}^n (i-m)^4 \end{bmatrix}^{-1} \begin{bmatrix} \sum_{i=1}^n T_i \\ \sum_{i=1}^n T_i i \\ \sum_{i=1}^n (i^2 T_i) - \sum_{i=m}^n [(i-m)^2 T_i] \end{bmatrix}$$

2.5.3 Linear-linear segmented regression model

The functional dependence (2.37) for the linear-linear segmented regression model uses two segments joined together at the switching point m .

$$Y_2(X) = \beta_{0,2} + \beta_{1,2}(X) + \beta_{2,2}(X - m)\phi(X - m) \quad (2.37)$$

The unknown coefficients $\beta_{0,2}$, $\beta_{1,2}$ and $\beta_{2,2}$. are calculated as follows:

$$\begin{bmatrix} \beta_{0,2} \\ \beta_{1,2} \\ \beta_{2,2} \end{bmatrix} = \begin{bmatrix} n & \sum_{i=1}^n i & \sum_{i=m}^n (i-m) \\ \sum_{i=1}^n i & \sum_{i=1}^n i^2 & \sum_{i=m}^n [i(i-m)] \\ \sum_{i=m}^n (i-m) & \sum_{i=m}^n [i(i-m)] & \sum_{i=m}^n (i-m)^2 \end{bmatrix}^{-1} \begin{bmatrix} \sum_{i=1}^n T_i \\ \sum_{i=1}^n (T_i i) \\ \sum_{i=m}^n [T_i (i-m)] \end{bmatrix}$$

2.5.4 Quadratic-quadratic segmented regression model

The quadratic-quadratic segmented regression model for predicting the time moment of the next failure of an ACSSS has the following form:

$$Y_3(X) = \beta_{0,3} + \beta_{1,3}X + \beta_{2,3}X^2 + \beta_{3,3}(X - m)\phi(X - m) + \beta_{4,3}(X - m)^2\phi(X - m) \quad (2.38)$$

The five unknown coefficients $\beta_{0,3}$, $\beta_{1,3}$, $\beta_{2,3}$, $\beta_{3,3}$ and $\beta_{4,3}$. are calculated as follows:

$$\begin{bmatrix} \beta_{0,3} \\ \beta_{1,3} \\ \beta_{2,3} \\ \beta_{3,3} \\ \beta_{4,3} \end{bmatrix} = \begin{bmatrix} n & \sum_{i=1}^n i & \sum_{i=1}^n i^2 & \sum_{i=m}^n (i-m) & \sum_{i=m}^n (i-m)^2 \\ \sum_{i=1}^n i & \sum_{i=1}^n i^2 & \sum_{i=1}^n i^3 & \sum_{i=m}^n [i(i-m)] & \sum_{i=m}^n [i(i-m)^2] \\ \sum_{i=1}^n i^2 & \sum_{i=1}^n i^3 & \sum_{i=1}^n i^4 & \sum_{i=m}^n [i^2(i-m)] & \sum_{i=m}^n [i^2(i-m)^2] \\ \sum_{i=m}^n (i-m) & \sum_{i=m}^n [i(i-m)] & \sum_{i=m}^n [i^2(i-m)] & \sum_{i=m}^n (i-m)^2 & \sum_{i=m}^n (i-m)^3 \\ \sum_{i=m}^n (i-m)^2 & \sum_{i=m}^n [i(i-m)^2] & \sum_{i=m}^n [i^2(i-m)^2] & \sum_{i=m}^n (i-m)^3 & \sum_{i=m}^n (i-m)^4 \end{bmatrix}^{-1} \begin{bmatrix} \sum_{i=1}^n T_i \\ \sum_{i=1}^n (T_i i) \\ \sum_{i=1}^n (T_i i^2) \\ \sum_{i=m}^n [(i-m)T_i] \\ \sum_{i=m}^n [(i-m)^2 T_i] \end{bmatrix}$$

After determining the co-efficient of all three segmented regression model, the value of the optimal switching point m is selected for each model based on the corresponding least value of standard deviation σ .

$$\sigma = \sqrt{\frac{1}{n-l} \sum_{i=1}^n (T_i - \hat{Y})^2}$$

where l is the degree of freedom for each of each selected model, \hat{Y} corresponds to the response variable for each of the segmented regression models i.e. $Y_1(X)$, $Y_2(X)$ and $Y_3(X)$. From the observations of m and σ , the optimal values of the switching point for the three segmented regression models are calculated. The segmented regression model that has the least value of m is considered the most precise prediction model for the flight hour at which a failure is likely to occur in the observed component, subsystem, system, or structure. The goodness of fit test for each of the model is visually carried out to check for fitting.

2.6 Mathematical models for forecasting aircraft spare parts

Billions of dollars is currently being spent in high technology aircraft in view of sustainable aviation. Aircraft systems are very complex and sophisticated owing to the number of functions and components. Failure and repair behaviors of aircraft system can be directly or indirectly associated with thousands of different safety implications and/or reliability expectations. Therefore, the activities of planning, design, management, control, and optimization of maintenance issues are very critical topics in aircraft operations.

Spare parts and maintenance are closely related because maintenance activities generate the need for spare parts; spare parts inventory serve maintenance planning. Spare parts account for 60-80% of maintenance expenditure [138] and 80% of downtime is caused by 20% of equipment [139]. Excessive spare parts lead to high holding costs and impedes cash flows while inadequate spare parts can result in expensive flight cancellations or delays with a negative impact on airline performance. The aircraft spare parts industry is unique because of

a combination of market characteristics: demand unpredictability, high cost of spare part related downtimes, traceability of parts for safety reasons and global need for parts [72]. The complexity of spare parts management has increased the percentage of procurement and storage costs in aircraft operations. According to the TeamSAI's statistics, the global civil aviation industry currently stores approximately \$50 billion in spare parts, which accounts for approximately 75% of airlines inventory funds and 25% of working capital. However, the turnover and utilization rate of most civil aircraft spare parts are low, only 25% are used, and even more there is a problem of excessive backlog [71]. Aircraft spare parts are categorized into three: 1) spare parts which can be rotated among any type of aircraft are classified as rotatable spare parts; (2) spare parts with characteristics similar to rotatable spare parts but with lower price are called repairable spare parts; (3) spare parts that can only be used once are classified as nonrepairable or consumable spare parts [140].

The numerous aircraft components and parts have their own inherent reliability and failure rate. In addition to this, different strategies are applied to improve the reliability of aircraft systems. These strategies include but are not limited to system redundancy and the use of a Minimum Equipment List (MEL). The MEL is a list which allows for aircraft operations subject to specific conditions in which a particular equipment, system or component is inoperative. It specifies a list of equipment, system or component that must be operable for the aircraft to be considered airworthy [141]. In Nigeria, most operators plan spare inventory based on the MEL – items not the MEL are kept in the inventory but considering logistic factors and the stochastic nature of failures, downtimes and delays due to lack of spare parts may occur. It is therefore important to develop a model which factors in failure rates of various component parts and system. This will improve the maintenance program and minimize the cost of operations.

This study proposes models and formulas for optimal spare parts planning. An algorithm is developed for the optimal forecast of spare parts demand (sufficiency) using a combination of analytical approaches. The models are tied to failure rates and probability of failure free

operations calculated based on real data. The failure rate gives reliable information for accurate forecast of spare parts need. The models can be combined for optimal result.

2.6.1 Reliability-centered models for aircraft spare parts management

Forecasting spare parts demand can be a difficult exercise because demand is stochastic in nature. However, a good knowledge of the failure trend and distribution can provide optimal solutions. Spare parts forecast can significantly improve if is based on trends and failure history. The models described in this section create an efficient spare parts inventory management to provide effective services for maintenance needs. In the context of the models developed, it is assumed that the items are non-repairable items and are not listed in the MEL. The models are focused on the interaction between failure rates and spare parts inventory. The Poisson method, which is based on the Poisson distribution predicts the probability of a rare event. When applied for spare parts forecasting, it provides an estimate of the consumption probability for a fixed value of spare parts [142]. The spare parts demand which is generated because of maintenance actions are described by Poisson distribution provided that the number events occurring in one interval are independent of the events occurring in any other interval [143].

Considering reliability parameters of aircraft system and component parts, Poisson distribution can be expressed as follows

$$f(x;\lambda,t) = \frac{(\lambda t)^x e^{-\lambda t}}{x!} \quad (2.39)$$

where λ is the failure rate, t is the observed time interval and x number of failures i.e., number of spare parts needed. The cumulative probability of the maximum consumption of spare parts x is given by

$$F(x;\lambda,t) = \sum_{k=0}^x \frac{(\lambda t)^k e^{-\lambda t}}{k!} \quad (2.40)$$

For the proposed model, the following assumptions are made:

- The component parts are non-repairable;
- The reliability of the item to be spared is expressed as a failure rate λ i.e. the inverse of MTBF;
- The number of the component parts (items) installed in the aircraft $N = 1..19$. The value for N is based on the component maintenance information extracted from maintenance planning data [144] – the highest value of the number of components is 19.
- The intended fill rate i.e. the probability of having a spare part in inventory when needed $P = 0.90..0.95$.
- The number of aircraft to be supported by the spare part inventory, $A = 1..50$
- The operational period to be supported given in calendar time (months), $T = 1..12$
- The average aircraft utilization U in flight hours per month

Model № 1

The steps for the spare parts forecasting model are as follows:

1. Choose an aircraft system or structure to further analyze its components for reliability parameters. It is assumed that the aircraft system consists of k simultaneously operating non-repairable components that are arranged in a parallel network as shown in Fig 2.6

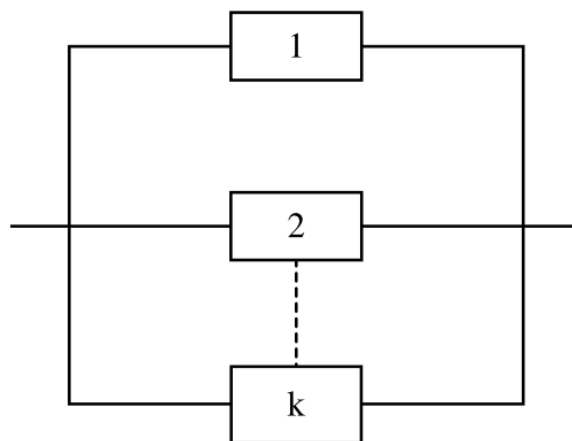

Fig. 2.6 Block diagram of k -components parallel system

2. Input data for $m \times 1$ matrix of λ
3. Input data for $m \times 1$ matrixes of x – for non-repairable aircraft component x is equal to the number of failures for the observed interval.
4. The probability of the required minimum quantity of k spares for i th component failure is expressed as

$$P_{k,i} = \sum_{x=0}^k \frac{(\lambda_i t)^x e^{-\lambda_i t}}{x!} \quad (2.41)$$

5. The output P is a table which allows for computing the number of required component parts to be kept in the inventory for the corresponding probability of the fill rate.

Model № 2

In the second model for forecasting spare parts demand, for the time interval t and a failure rate λ_i , the probability of the number of failures x_i (which is equal to the n_i spare parts) is expressed by Poisson formula

$$Pn_i(t) = \frac{(\lambda_i t)^{n_i}}{n_i!} e^{(-\lambda_i t)} \quad (2.42)$$

where $n_i = \{1,2,3,\dots\}$. Formula (2.42) can be described using the exponential law and is expressed as

$$P_{n_i=0} = e^{(-\lambda t)} \quad (2.43)$$

The probability that the spare parts in the inventory will be sufficient for the aircraft operation is defined as

$$P_i(t) = \sum_{n_i=0}^{n_i} \frac{e^{(-x_i)} x_i^{n_i}}{n_i!} \quad (2.44)$$

The function $P_i(n_i, x_i)$ for computing the required number of spare parts n_i is plotted as nomogram using λ_i of each component of the aircraft system considered.

Goodness-of-fit test

For both models, an analytical goodness of fit test using MCS method is carried out for the output \mathbf{P} (equation 2.41) and the nomogram (equation 2.44). For each i th component, find the first value for which the probability $\mathbf{P} = \mathbf{0.90}$ (or any figure 0.80...0.95), select the corresponding k quantity of spare and designate this as $\mathbf{m=k+1}$. For the simulation, $\mathbf{M=10000}$ iterations and the simulation process is as follows

$$\text{Step 1} \quad B_j = \sum_{i=0}^{m-1} A_{i,j} \text{ where } A_{i,j} \text{ is an exponential distribution } [1, \lambda_i]$$

$$\text{Step 2} \quad C_j = \begin{cases} 1 & \text{if } B_j > t \\ 0 & \text{otherwise} \end{cases}$$

$$\text{Step 3} \quad P = \frac{\sum_{j=0}^{M-1} C_j}{M}$$

For validity of the model, the value of P_i should correspond to the value in the output table P and the Nomogram. This proves the accuracy of the models for forecasting aircraft spare part demand. Furthermore, the results of both models for each failure rate λ_i should be the same.

CONCLUSIONS

1. The operations phase of aircraft lifecycle generates most of the statistical data in the aircraft life cycle which can be used to generate statistical data processing algorithms for improving the efficiency of aircraft operations. This forms the basis for this chapter for developing mathematical models and algorithms for the optimization of aircraft maintenance processes for continuing airworthiness.

2. A statistical simulation model based on exponential distribution for reliability analysis of aircraft components, subsystems, systems and structures given a dataset > 35 was developed in section 2.2.1.
3. A statistical simulation model for reliability analysis of aircraft components, subsystems, systems, and structures given a dataset < 35 is developed in 2.2.2. The proposed model calculates the failure rate based on the probability of failure-free operations which is determined using Kazakyavicius equation.
4. A review of relevant literature shows that no study has proposed reliability models based on time between failures, observed time and repair cost to improve the efficiency of aircraft operations. This forms the basis for the developing a mathematical model for the optimization of aircraft maintenance task intervals in section 2.3. The exponential and Erlang models were considered; for the exponential model of time between failures, the analytical calculations showed that the possibility of optimizing maintenance task interval does not exist. On the other hand, a minimum which corresponds to the optimal maintenance task intervals exists for the Erlang model. These models quantify the cost and benefits of maintenance with the goal of obtaining an optimum balance between both.
5. The application of segmented regression in aircraft operations allows for increased correctness for the calculation of extreme probability values of occurrence of failures in aircraft components, subsystems, systems, and structures. In section 2.4, three segmented regression models were developed: quadratic-linear segmented regression model, linear-linear segmented regression model and quadratic-quadratic segmented regression model. The models for determining the coefficient of each of the model was also determined.
6. Spare parts and aircraft maintenance are closely related because maintenance activities generate the need for spare parts; spare parts inventory serve maintenance planning. Spare parts account for 60-80% of maintenance expenditure and 80% of downtime is caused by 20% of equipment. In section 2.5, an algorithm is developed

for the optimal forecast of aircraft spare parts demand (sufficiency) using a combination of analytical approaches. The proposed model is based on reliability parameters and Poisson distribution.

CHAPTER 3. ANALYSIS OF PROPOSED MATHEMATICAL MODELS FOR THE OPTIMIZATION OF AIRCRAFT MAINTENANCE PROCESSES FOR CONTINUING AIRWORTHINESS

In chapter 2, various models were developed which can form the framework for an optimized aircraft maintenance process which is predictive, and data driven. Furthermore, the civil aviation industry needs realism in mathematical models and the way optimization problem is formulated; system reliability, maintenance processes and cost must be considered during the design and manufacturing phases of aircraft lifecycle; these proposed models can serve as a basis for this. The validity of the proposed models is checked in this chapter using daily aircraft operations data from Nigeria. An overview of predictive data-driven aircraft maintenance is given to justify this approach. As stated in previous chapters, the term ‘failure’ refers to faults and failures of aircraft components, subsystems, systems, or structures.

3.1 An overview of predictive aircraft maintenance

The most widely applied aircraft maintenance strategies are CM and PM actions. CM tasks are connected to run-to-failure maintenance strategies while PM work is performed as part of a fixed interval to replace, repair, or restore. It encompasses work done under a fixed-interval restoration/repair strategy and conducted based on a time or machine-run-based schedule that detects, precludes, or mitigates degradation [3]. These traditional aircraft maintenance strategies lack predictive capability and often lead to maintenance being performed too early, i.e., before the end of a machine’s useful life, or too late, i.e., after a costly failure [4]. Therefore, data-driven predictive and condition-based aircraft maintenance approach will result in lower maintenance costs, avoiding unnecessary PM actions and reducing unexpected failures. A combination of PM and PdM results in 18.5 % less unplanned

downtime and 87.3 % less defects for more reliance on predictive than preventive maintenance [145].

Predictive Maintenance is one of the core pillars of Industry 4.0 and in comparison to CM and PM, it allows for more cost-effective operations. It is performed as part of a condition-based strategy which involves measuring the condition of equipment and assessing whether it will fail during some future period. Early approaches to PdM focused on hand-crafted, physical models and heuristics and lately, data-driven methods are on the rise because they can be scaled to multiple systems without the need for specific domain knowledge [146-147]. Cloud-computing, wider availability of data and models and other industry 4.0 developments are creating a paradigm shift in how maintenance work is planned and executed. In the nearest future, aircraft maintenance will be initiated once a potential failure has been detected and thus completed prior to the occurrence of functional failure. PdM tasks are determined by the OEM's recommendations and strategy development decision trees such as RCM that considers failure behavior and consequence [3].

Data-driven predictive aircraft maintenance

Data-driven maintenance methods originate from statistics and machine learning techniques. To use data-driven methods in a purposeful way, structural understanding of the behavior being modelled is not needed but run-to-failure data for each fault mode of the system should be made available [148]. In [4], the authors investigated how historical machine failures and maintenance records can be used to determine future estimates of machine failure and, consecutively, prescribe improvements of scheduled preventive maintenance interventions. The authors modelled the problem using a finite horizon Markov decision process with a variable order Markov chain, in which the chain length varies based on the time since the last preventive maintenance action was conducted. The prescriptive optimization model captures the dependency of a machine's failures on both recent failures in addition to preventive

maintenance actions. To improve predictions for machine failure behavior, the authors pooled dataset over different machine classes using a Poisson generalized linear model [4].

Operational data such as past aircraft failures and maintenance actions can be used to estimate the probability of ACSSS failure and plan maintenance actions accordingly. In this chapter, the models developed in the previous chapter will be applied to real-life aircraft operations data to validate the proposed models and prove their applicability. Historical dataset of pilot and maintenance records of failures from aircrafts operating in Nigeria are utilized for this study. The datasets were preprocessed as shown in chapter 1 but to be used input data for the proposed models, further transformation was carried to obtain more usable forms of data. The results of the analysis described in this chapter can provide insights into future failures of ACSSS – it can supplement an existing aircraft maintenance strategy. This results in reduced waste which arises due to early maintenance and failure costs connected with late maintenance actions [4].

3.2. Reliability analysis of aircraft components, subsystems, systems, and structures given a large dataset

The operational phase of aircraft life cycle generates statistical data that can be used to determine the reliability of aircraft components and systems. A model based on exponential distribution was described in the previous chapter and the methodology is given in Fig. 3.1. To test the model, statistical data was generated from pilot and maintenance reports of aircraft for three MD–83 aircraft over an operational period of four years [149]. As shown in Table 1, the failure information of each aircraft system and structure was grouped according to the ATA Spec 100 numbering system – n_T refers to the total number of failures observed by both pilots and maintenance personnel for the time interval.

The input data is a matrix of n_T and $B_{i+1}-B_i$ is the probability of i -th component failure. The values of B_i are shown in Table 2 and the graph (Fig.3.2) is used to visually analyze how the failures occur. The simulation is performed for 10000 iterations and the probability density

functions (PDFs) are plotted based on the output. For this study, the top-most failing ATA Spec 100 will be analyzed i.e., ATAs 21, 22, 23, 24, 25, 32, 33, 34, 49 and 52.

Table. 3.1

Failure information of aircraft systems and structures

ATA	n _T	ATA	n _T	ATA	n _T	ATA	n _T
21	734	30	77	45	1	72	46
22	142	31	30	46	2	73	52
23	321	32	965	49	199	74	12
24	250	33	1239	51	6	75	22
25	1869	34	378	52	113	76	18
26	85	35	73	53	8	77	29
27	104	36	30	56	26	78	21
28	62	38	68	57	3	79	37
29	52	39	1	71	28	80	40

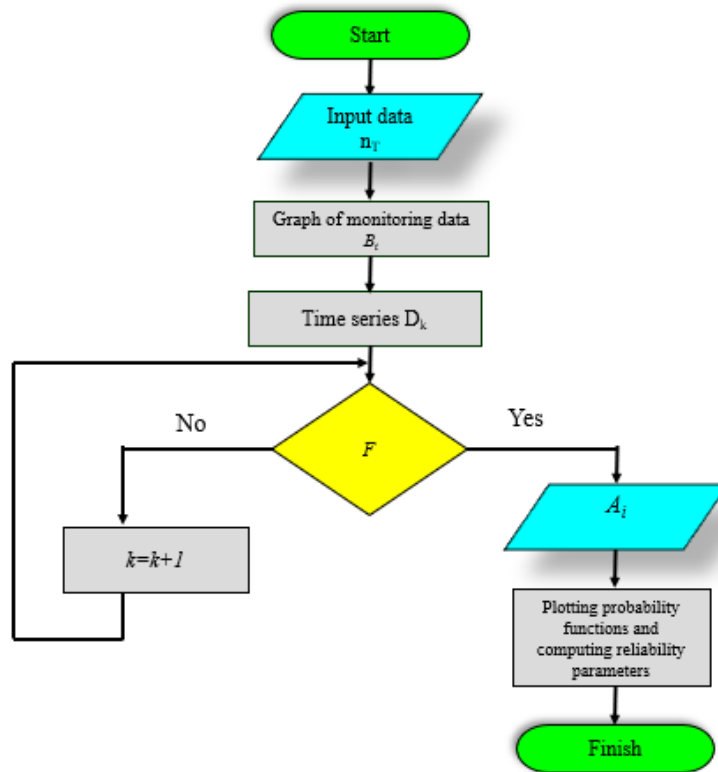

Fig. 3.1. Flowchart for reliability analysis based on exponential distribution

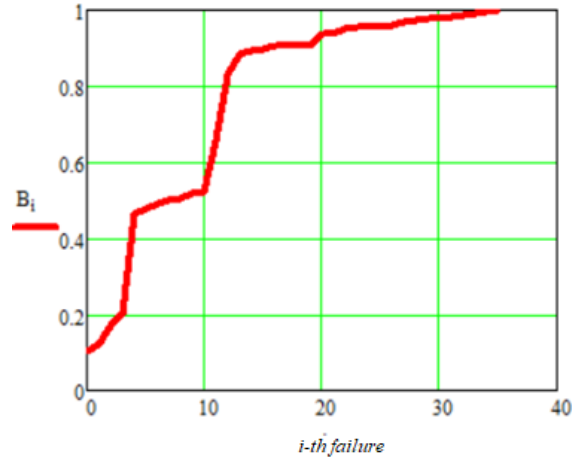

Fig 3.2. Graph of monitoring data

Table. 3.2

Cumulative number of observed failures in time B_i

B_i		B_i		B_i		B_i	
B_1	0.103	B_{10}	0.517	B_{19}	0.907	B_{28}	0.968
B_2	0.123	B_{11}	0.522	B_{20}	0.908	B_{29}	0.975
B_3	0.168	B_{12}	0.657	B_{21}	0.935	B_{30}	0.977
B_4	0.203	B_{13}	0.830	B_{22}	0.936	B_{31}	0.980
B_5	0.464	B_{14}	0.883	B_{23}	0.952	B_{32}	0.982
B_6	0.476	B_{15}	0.893	B_{24}	0.953	B_{33}	0.986
B_7	0.491	B_{16}	0.898	B_{25}	0.957	B_{34}	0.989
B_8	0.499	B_{17}	0.907	B_{26}	0.957	B_{35}	0.994
B_9	0.507	B_{18}	0.907	B_{27}	0.961	B_{36}	1.000

The PDFs of the top-most failing ATAs are in Fig. 3.3 – 3.12. The reliability indices of each of the aircraft system or structure are further calculated and are shown in Table 3. 3

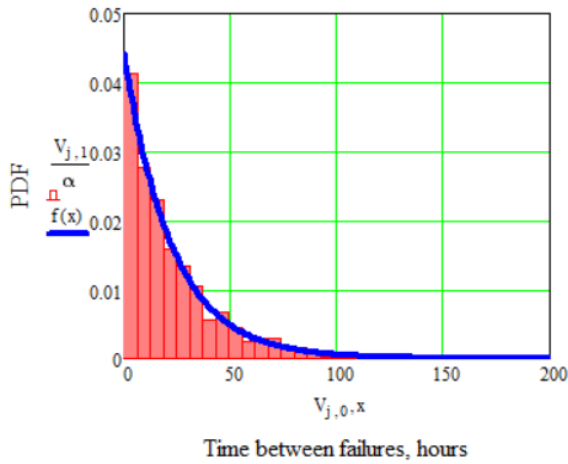

Fig. 3.3. Probability density function of observed time between failures for the air-conditioning system

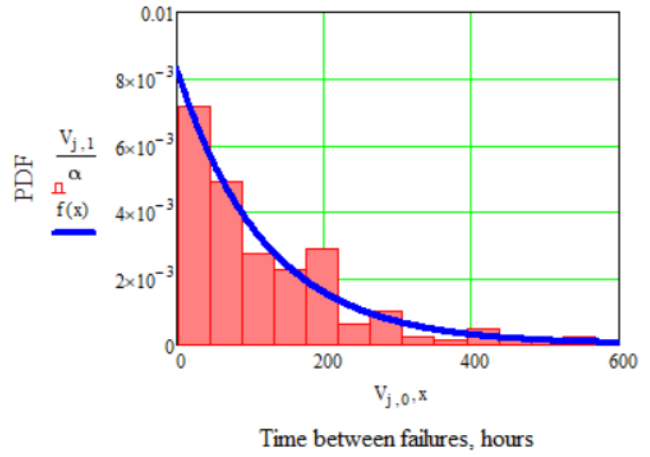

Fig. 3.4. Probability density function of observed time between failures for auto flight system

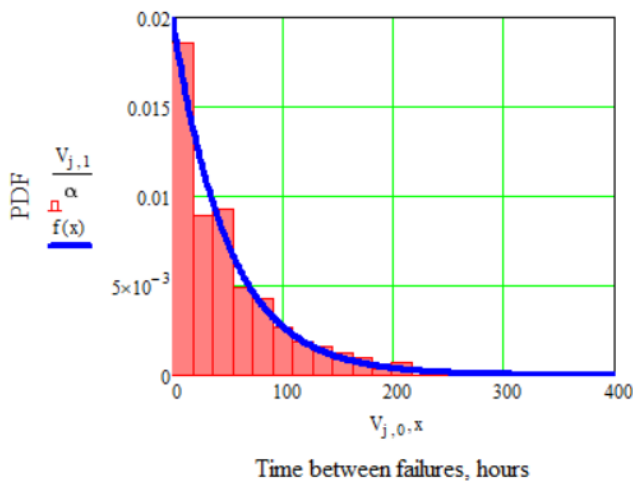

Fig. 3.5 Probability density function of observed time between failures for the communication system

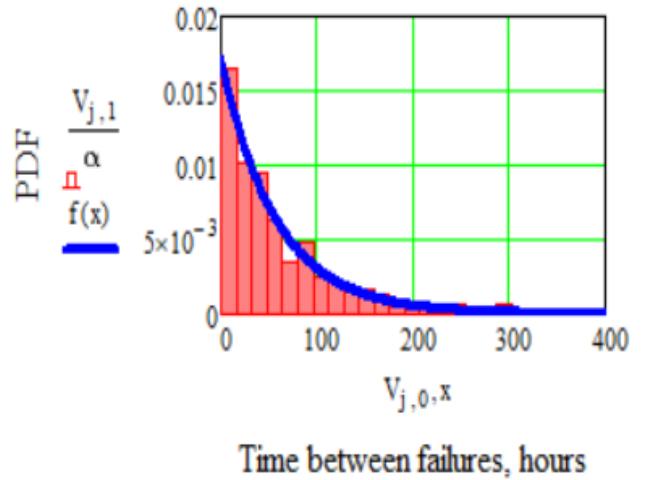

Fig. 3.6 Probability density function of observed time between failures for the electrical power system

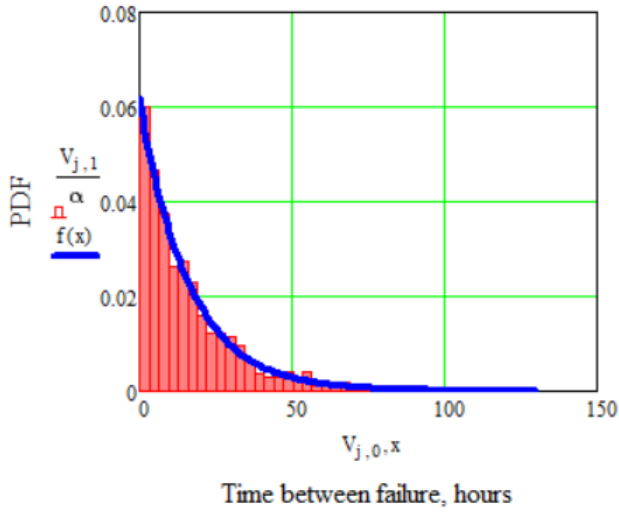

Fig. 3.7. Probability density function of observed time between failures for the furnishing

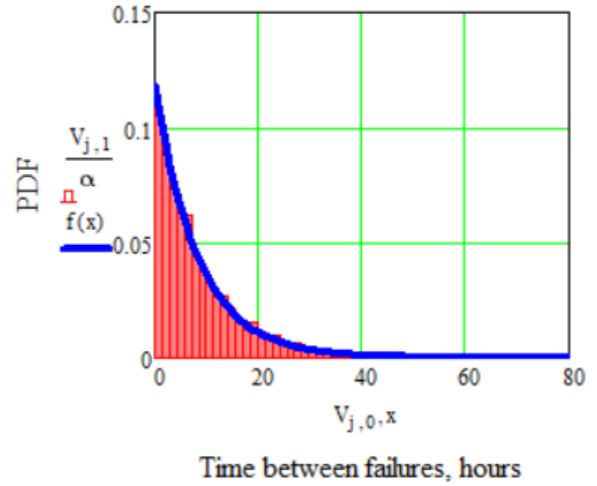

Fig. 3.8. Probability density function of observed time between failures for the landing gear

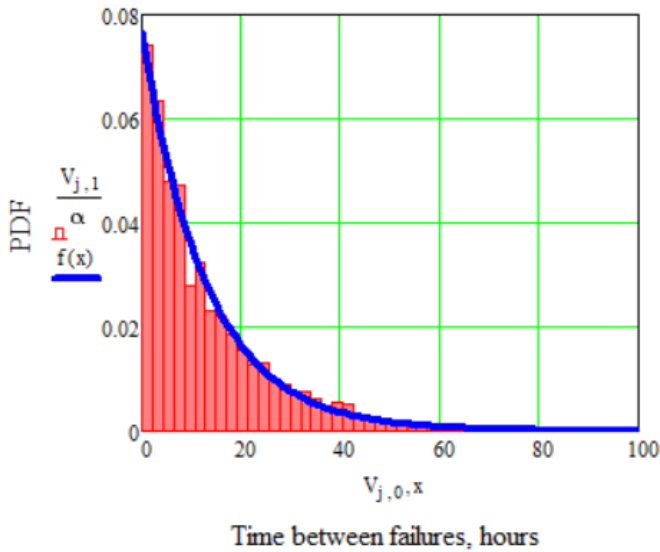

Fig. 3.9. Probability density function of observed time between failures for the light system

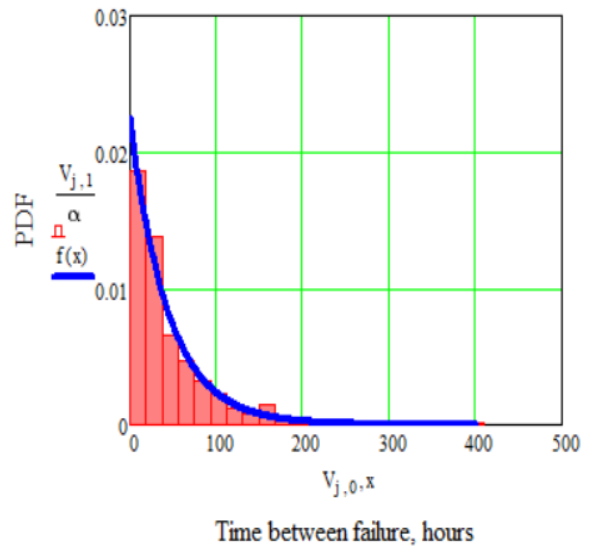

Fig. 3.10. Probability density function of observed time between failures for the navigation system

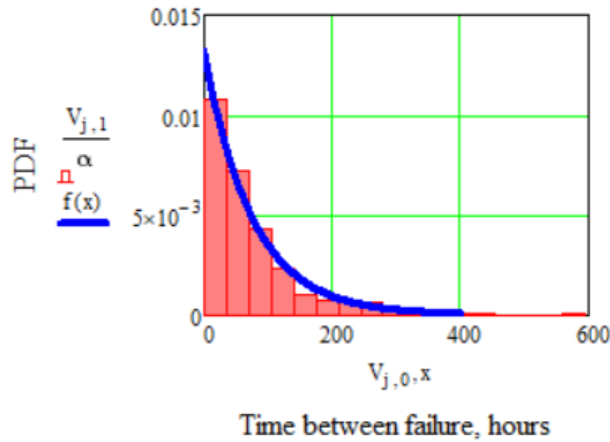

Fig. 3.11. Probability density function of observed time between failures for the airborne auxiliary power

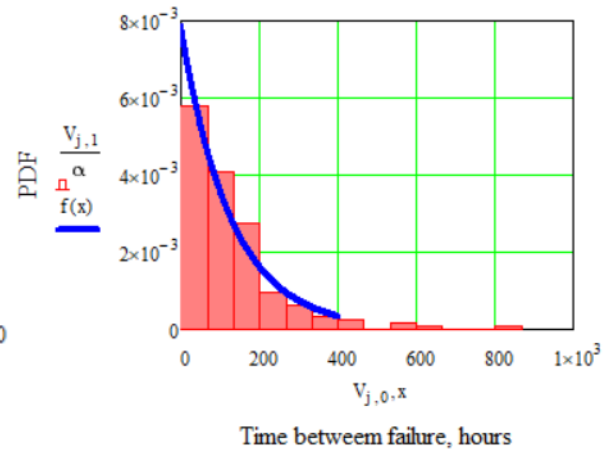

Fig 3.12. Probability density function of observed time between failures for the Doors

Table 3.3

Reliability indices based on the PDFs

ATA	ATA Chapter Name	MTBF _{calc}	λ_{calc}	$K_{1000 calc}$
21	Air conditioning	22.601	0.044	44
22	Auto flight	120.289	0.008	8
23	Communications	50.271	0.020	20
24	Electrical power	58.204	0.017	17
25	Equipment/furnishings	8.475	0.118	118
32	Landing gear	16.214	0.062	62
33	Lights	13.076	0.076	76
34	Navigation	44.419	0.023	23
49	Airborne auxiliary power	75.507	0.013	13
52	Doors	126.959	0.008	8

The goodness-of-fit test is applied to the mathematical model to verify if it obeys the exponential distribution. The χ^2 -test was chosen to test the goodness of fit using one of the obtained PDFs and following value was the result:

$$\chi_{calc}^2 = 13.531$$

The calculated χ^2 is less than the threshold value $\chi_{th}^2 = 19.675$. Therefore, the hypothesis for the exponential distribution law of mean time between failures of aircraft systems and structures is accepted with a significance level equal to 0.05. Additionally, the theoretical exponential distribution is given as:

$$f(t) = \lambda_{calc} e^{-\lambda_{calc} t} \Phi(t)$$

where λ_{calc} is the failure rate calculated based on the resulting PDF for each ATA chapter, $\Phi(t)$ is the Heaviside function. The blue line in all the PDFs proves that the simulation results coincide with theoretical distribution. The limitation of this study is that it requires a minimum sample size of 35 and may not be suitable for aircraft operations which generate a small dataset [19, 26, 29, 95, 97, 106, 150]. Therefore, another methodology for reliability analysis for small dataset was developed in the previous chapter and in the next section, real-life operational dataset will be used to prove its applicability.

3.3 Reliability analysis of aircraft components, subsystems, systems, and structures given a small dataset.

The relationship between reliability and failure probability of an aircraft component or system j is given by

$$P(\bar{j}) = 1 - R_{cs} \quad (3.1)$$

where $P(\bar{j})$ – failure probability and R_{cs} – reliability. The proposed methodology for reliability analysis for small dataset is based on first finding the failure probability as described in the Fig. 3.13 [151-156].

Real-life historical dataset of pilot and maintenance reports of failures from an aircraft operating in Nigeria is utilized for this study. To further reduce the sample size, one system was selected from a basic sample of the statistical data and the dataset was transformed to a

more usable form to be used as input data for the proposed algorithm. The number of failures n_{TS} are given in Table 3.4.

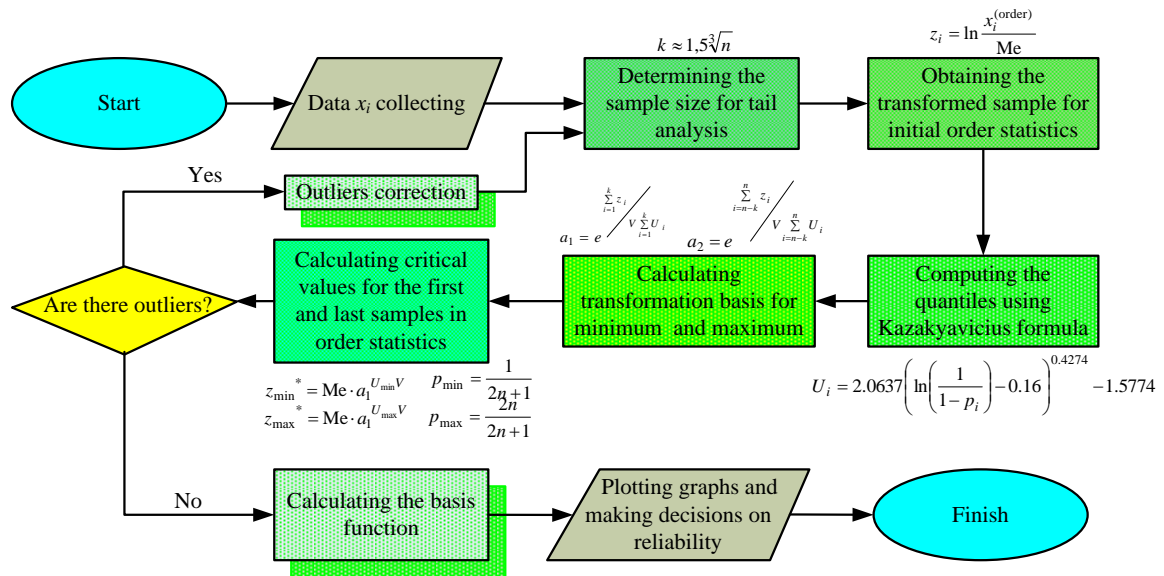

Fig. 3.13. Flow chart of the methodology for reliability analysis given a small dataset

Table 3.4

Failure information of an aircraft system

x_i	n_{TS}	x_i	n_{TS}	x_i	n_{TS}	x_i	n_{TS}	x_i	n_{TS}
x_0	3	x_3	1	x_6	3	x_9	5	x_{12}	4
x_1	1	x_4	8	x_7	3	x_{10}	7	x_{13}	5
x_2	1	x_5	2	x_8	5	x_{11}	10	x_{14}	9

There are no outliers therefore the Chauvenet’s criterion is not applied.

$$j = 3.615 ; \delta_1 = -2.273; \delta_2 = 1.727$$

Corresponding quantiles of the standard normal distribution are shown in Table 3.5

Table 3.5

Quantiles of the standard normal distribution

K_i		K_i		K_i		K_i		K_i	
K_0	-3.111	K_3	-2.252	K_6	-1.735	K_9	1.897	K_{12}	2.464
K_1	-2.727	K_4	-2.066	K_7	0	K_{10}	2.066	K_{13}	2.727
K_2	-2.464	K_5	-1.897	K_8	1.735	K_{11}	2.252	K_{14}	3.111

$$\delta_{k \min} = -3.693; \delta_{k \max} = 3.693; \beta_1 = 2.119; \beta_2 = 1.596$$

The values of the basis function are given in Tables 3.6-3.7

Table 3.6

Values of basis function $F_1 (K_i)$

$F_1 (K_i)$		$F_1 (K_i)$		$F_1 (K_i)$		$F_1 (K_i)$		$F_1 (K_i)$	
$F_1 (K_0)$	2.118	$F_1 (K_3)$	2.113	$F_1 (K_6)$	2.103	$F_1 (K_9)$	1.608	$F_1 (K_{12})$	1.600
$F_1 (K_1)$	2.117	$F_1 (K_4)$	2.111	$F_1 (K_7)$	1.858	$F_1 (K_{10})$	1.605	$F_1 (K_{13})$	1.599
$F_1 (K_2)$	2.115	$F_1 (K_5)$	2.107	$F_1 (K_8)$	1.612	$F_1 (K_{11})$	1.602	$F_1 (K_{14})$	1.597

Table 3.7

Values of basis function $F_2 (K_i)$

$F_2 (K_i)$		$F_2 (K_i)$		$F_2 (K_i)$		$F_2 (K_i)$		$F_2 (K_i)$	
$F_2 (K_0)$	2.119	$F_2 (K_3)$	2.707	$F_2 (K_6)$	2.572	$F_2 (K_9)$	1.623	$F_2 (K_{12})$	1.475
$F_2 (K_1)$	2.831	$F_2 (K_4)$	2.659	$F_2 (K_7)$	2.119	$F_2 (K_{10})$	1.579	$F_2 (K_{13})$	1.407
$F_2 (K_2)$	2.762	$F_2 (K_5)$	2.614	$F_2 (K_8)$	1.666	$F_2 (K_{11})$	1.531	$F_2 (K_{14})$	1.596

The prognostic variables Q_1 and Q_2 , are calculated based on the proposed methodology for reliability analysis given a small dataset. The graph in Fig. 3.14 shows the quantiles of normal distribution according to Kazakyavicius equation. An additional graph (fig. 3.15) referred to as the failure probability graph is also plotted in accordance with formula (3.2).

$$p(x) = -e \left[\left(\frac{x}{2.0637} \right)^{\frac{1}{0.4274} + 0.16} \right] + 1 \quad (3.2)$$

where $p(x)$ is the failure probability

To determine the reliability of an aircraft component, subsystem or system over a given period, the first step is to determine the quantile after which the failure probability is determined using Fig. 3.14. For example, the forecast of five failures is in the 0.7 quantile, this corresponds to a failure probability (fig 3.15) of 0.25 (25%) and reliability of 0.75 (75%).

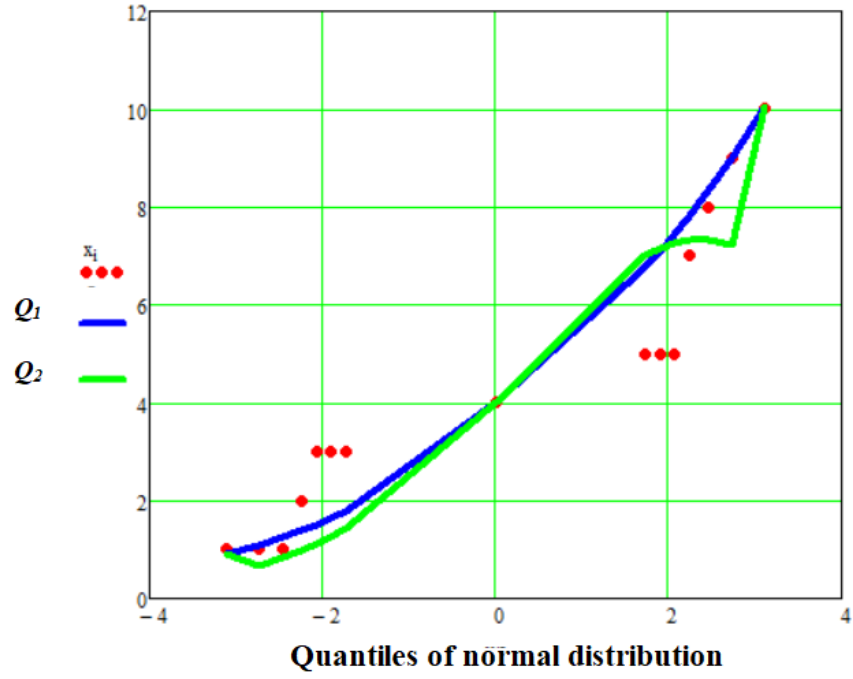

Fig. 3.14. Quantiles of normal distribution

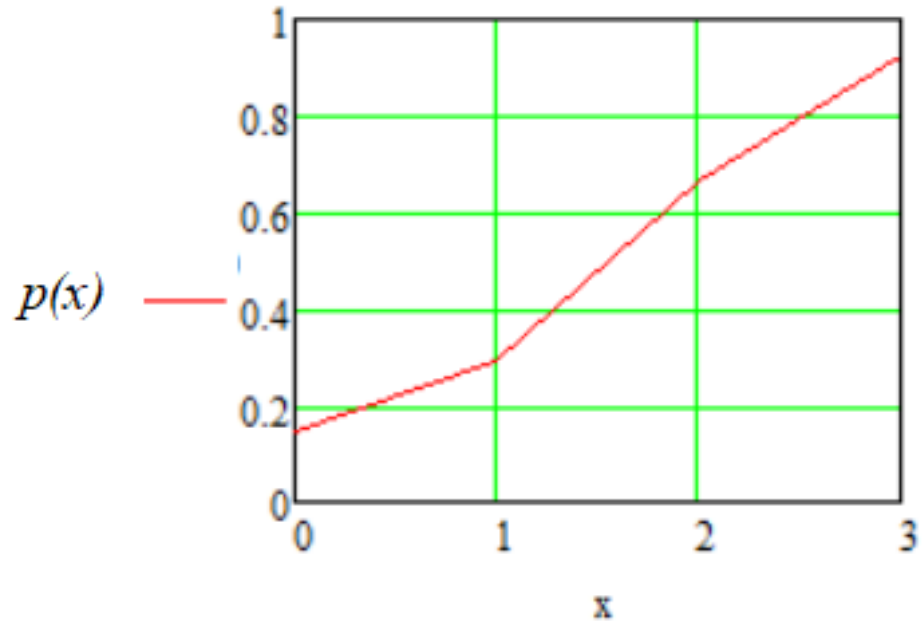

Fig. 3.15. Failure probability graph

The goodness of fit test is carried out visually using fig 3.14; the prognostic variables Q_1 and Q_2 are in accordance with the proposed model while x_i is based on the exponential distribution. The dots which do not connect for x_i visually proves that the model based on exponential distribution isn't suitable for a small dataset.

3.4. Optimal regression model for predicting time moment of aircraft component, system, or structure's failure

To predict the time moment at which a failure will occur, three segmented models were previously developed in this dissertation. To determine which of the segmented regression models gives the most prediction accuracy, all models will be tested using real-life aircraft operational data from one of the aircraft analyzed in chapter 1. The selected aircraft system is further transformed for the analysis (Table 3.8)

Table 3.8

Statistical data generated from aircraft operations

Failure i	Time between failures	Failure i	Time between failures	Failure i	Time between failures	Failure i	Time between failures
1	0	19	1.5000	37	2.5000	55	24.9501
2	510.9672	20	3.3333	38	0.1000	56	32.6334
3	17.0833	21	6.3833	39	2.5000	57	2.4500
4	0.0833	22	0.4000	40	2.5000	58	44.7332
5	20.2667	23	0.4000	41	4.3000	59	5.0333
6	4.336	24	0.4000	42	1.8333	60	10.3833
7	54.6334	25	0.0833	43	1.8333	61	13.3600
8	90.8332	26	0.0833	44	1.8333	62	0.1333
9	161.7500	27	33.2168	45	1.8333	63	0.1333
10	0.5000	28	48.7167	46	1.8333	64	0.6167
11	4.1667	29	5.6667	47	1.8333	65	0.3334
12	4.1667	30	2.4833	48	20.9167	66	2.6667
13	56.0999	31	78.2099	49	2.4167	67	83.8634
14	56.0999	32	4.3333	50	1.5667	68	22.4334
15	330.5002	33	1.5000	51	8.2334	69	11.3999
16	111.7334	34	8.8166	52	18.9332	70	3.0666
17	42.7768	35	0.1000	53	18.9332		
18	1.5000	36	0.1000	54	53.1834		

The transformed statistical data is a matrix A and is the input data for the simulation. Each of the proposed segmented model is tested using the input data and the graphs plotted to check the fitting (fig. 3.16 - 3.18). The matrix of unknown coefficients for each model is calculated using the ordinary least square method.

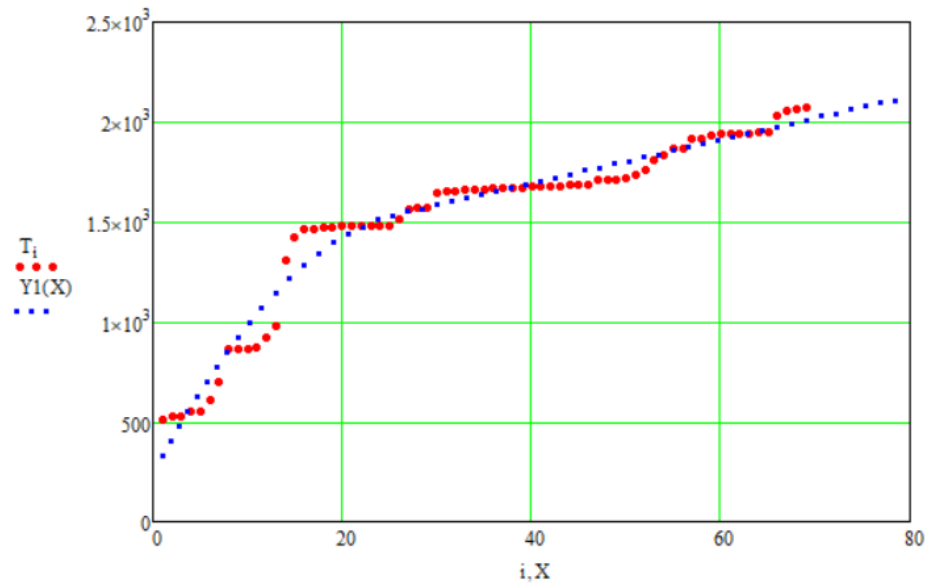

Fig. 3.16. Quadratic-linear segmented regression model

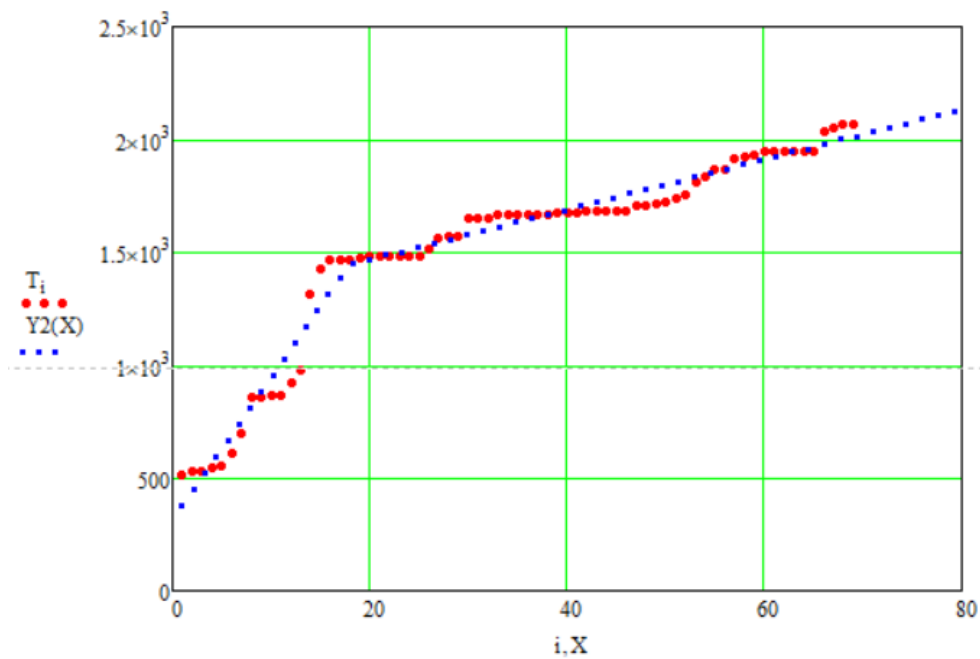

Fig. 3.17. Linear-linear segmented regression model

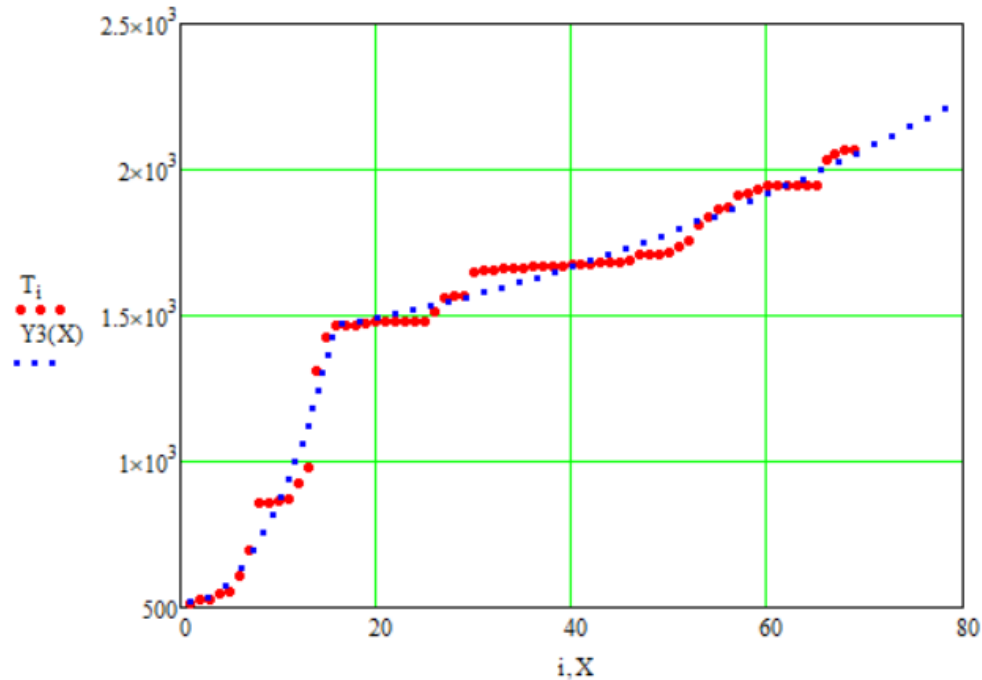

Fig. 3.18. Quadratic-quadratic segmented regression model

Designing an accurate predictive model involves fitting it to a set of training data and then adjusting its parameters such that this model will be able to make reliable predictions on new untrained data. Overfitting or underfitting is a common concern when designing a predictive model and it is possible to create a complex structure when fitting the regression model which results in poor performance [133]. Fig. 3.19 illustrates this problem, and we compare it to Fig 3.16 - 3.18 to confirm that the three proposed regression models in chapter 2 can be used to forecast time moments of failures of aircraft component, sub-system, system or structure.

To determine which of the three models gives the most precise prediction and at which optimal switching point m , analysis of the values of standard deviation σ for each value of $m=15-30$ is carried out. The results are given in Table 3.9 – Y1, Y2 and Y3 respectively refer to quadratic-linear segmented model, linear-linear segmented model, and quadratic-quadratic segmented model [137, 157-166].

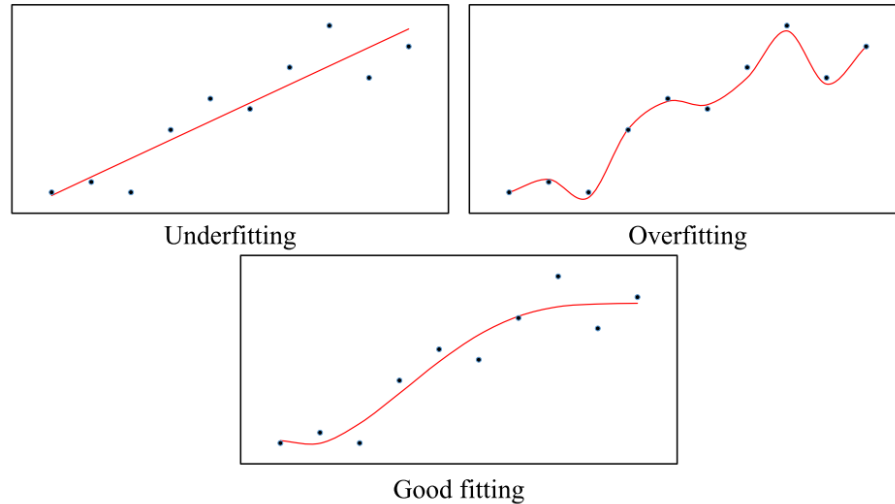

Fig. 3.19 Pictorial representation of over- and underfitting in regression [133]

Table 3.9

Values of standard deviation σ for each value of $m=15-30$

m	σ			m	σ		
	$Y1$	$Y2$	$Y3$		$Y1$	$Y2$	$Y3$
15	115.084	74.426	51.332	23	80.537	84.681	72.787
16	108.777	67.825	47.939	24	79.201	89.517	73.757
17	102.827	64.736	50.674	25	78.425	94.120	74.199
18	97.404	64.643	55.727	26	78.127	98.415	74.243
19	92.615	66.781	60.859	27	78.232	102.525	74.104
20	88.523	70.386	65.227	28	78.683	106.613	73.949
21	85.154	74.862	68.655	29	79.434	110.618	73.780
22	82.503	79.730	71.137	30	80.435	114.485	73.599

According to Table 3.9, the least value of standard deviation σ is observed with the quadratic-quadratic segmented model when $m=16$. Therefore, this model is considered the most precise of the three proposed regression models for predicting failure of an aircraft component, subsystem, system, or structure. Based on the resulting matrix of coefficients of the quadratic-quadratic segmented regression model, the final formula for the prediction is given as follows

$$Y_3(X) = 523.85 - 8.307X + 4.201X^2 - 119.969(X-16)\phi(X-16) - 4.107(X-16)^2\phi(X-16) \quad (3.3)$$

3.5 An approach to optimizing maintenance task interval of aircraft components, subsystems, systems, or structures

A significant percentage of maintenance cost is attributed to failures of aircraft components and systems. These failures are random and provide a database which can further be analyzed to aid decision-making for maintenance optimization. Maintenance optimization tasks of ACSST can be conducted based on analytical, numerical or simulation approaches (fig. 3.20). The analytical approach is based on the determination of exact equation; the numerical approach is based on descent methods, evolutionary methods, and pattern search methods; the simulation approach is based on Monte-Carlo methods [167-168]

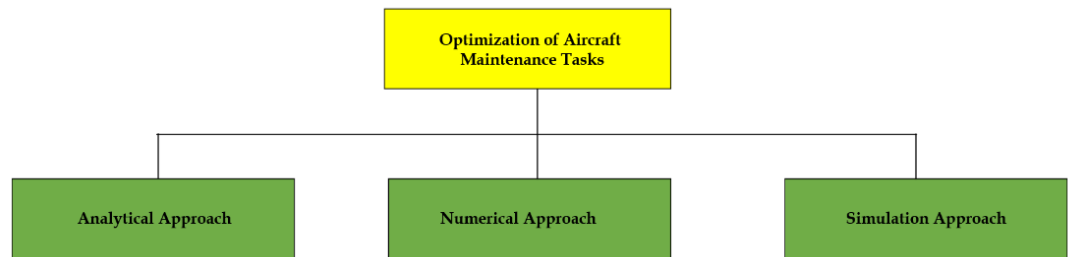

Fig. 3.20. Approaches to optimizing aircraft maintenance task interval

To determine an optimal maintenance task interval of aircraft systems, mathematical models which consider the average operational cost per unit time $E(C/t_M)$ as a measure of efficiency were analyzed for optimality in the previous chapter using the methodology in Fig. 3.21.

To prove the applicability of the model, simulation analysis was performed. The initial data are diagnostic variables and reliability parameters which formed the basis for selecting the PDF for TBF according to the exponential and Erlang models. Based on the PDF, the efficiency of the maintenance processes was calculated using average operational cost per unit time. For the exponential model, the initial data (TBF) is exponentially distributed with failure rate $\lambda = 0.001$ and sample size $n = 1000$, PM cost $C_M = 100$ and CM cost $C_R = 1000$, number of iterations $N = 10000$ [169].

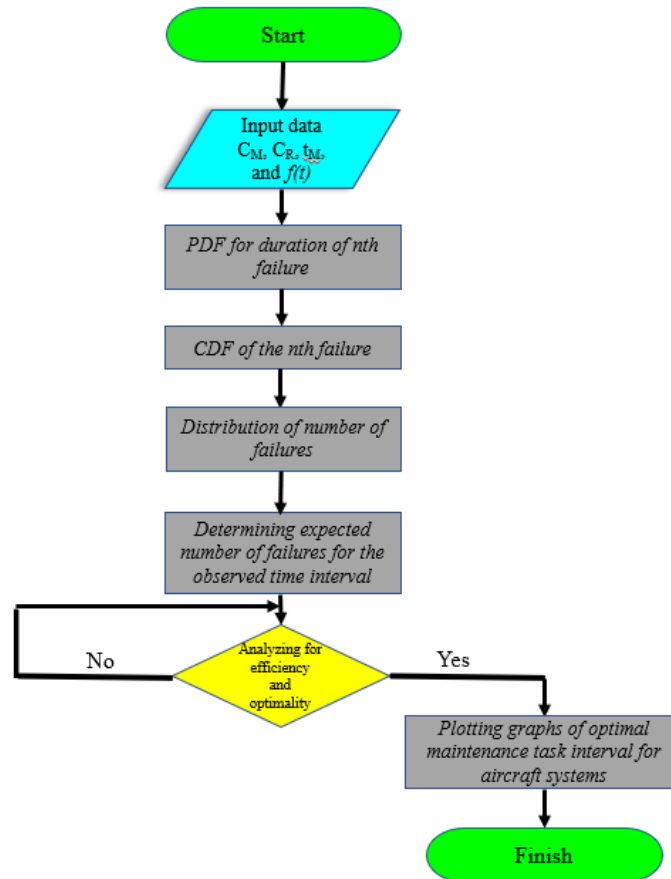

Fig. 3.21. Flowchart for determining optimal maintenance task interval for aircraft systems

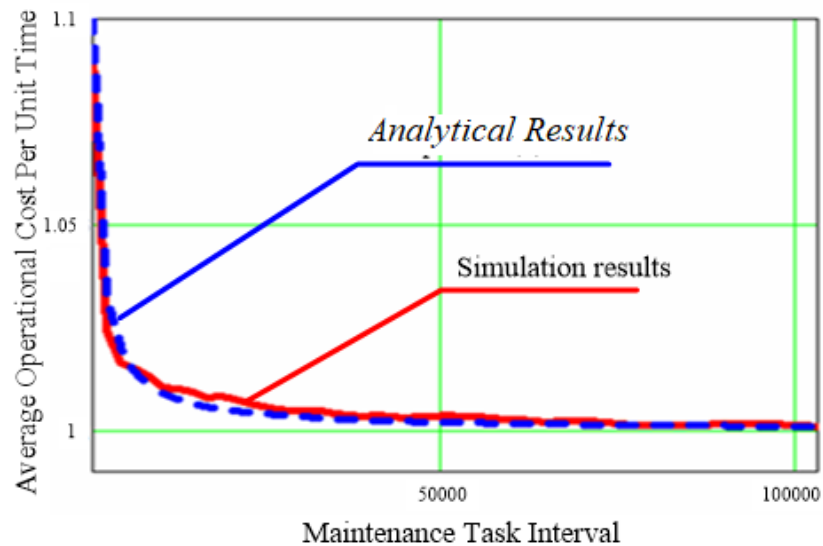

Fig. 3.22. The dependence of efficiency on maintenance task interval obtained based on analytical equation (blue line) and statistical simulation (red line) for exponential time between failures

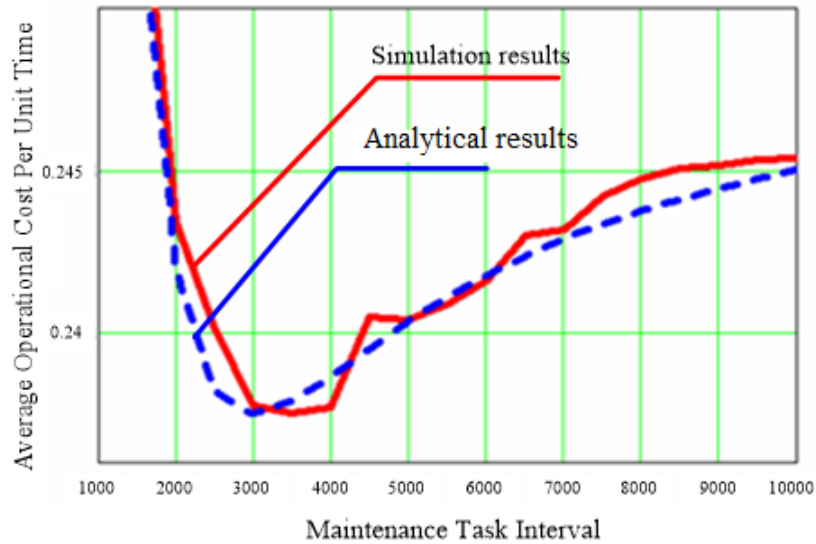

Fig. 3.23. The dependence of efficiency on maintenance task interval obtained based on analytical equation (blue line) and statistical simulation (red line) for Erlang distribution of time between failures.

Simulation results shown in fig. 3.22 prove that for the exponential model TBF, an optimal maintenance task interval which corresponds to a local minimum point on the graph of average operational cost per unit time vs maintenance task interval T_M does not exist; $T_{Mopt} \rightarrow \infty$. For the Erlang model, the initial data are $\lambda = 0.0005$, sample size $n = 1000$, PM cost $C_M = 200$ and CM cost $C_R = 1000$, number of repetitions $N = 10000$. The simulation results in Fig. 23 prove the existence of a “minimum” which corresponds to an optimal maintenance task interval. The simulation results in this chapter coincide with the analytical results in chapter 2 and further proves that it is possible to optimize maintenance task interval of ACSSS using the Erlang model [169].

3.6. Planning spare parts inventory during aircraft operation

Spare parts are common inventory stock items, which exist to satisfy maintenance needs. Spare parts unavailability may prolong aircraft downtime and incur unnecessary costs – its provision and planned maintenance are related logistic activities and should be considered

together [170]. In section 2.5 of this dissertation, an algorithm is developed for forecasting spare parts demand using a combination of analytical approaches. The models which are tied to probability of failure-free operations and failure rates (Section 3.1) are calculated based on real-life statistical data generated by aircraft operations. The process of spare parts management is shown in Fig. 3.24. Based on the results of condition monitoring, the failure of any aircraft component can be detected. This system is replaced by corresponding spare part that is in serviceable condition with probability equal to one. To analyse the applicability of the proposed model in section 2.4, operational data from pilot and maintenance reports of an aircraft operating in Nigeria is generated [149]. The component failures of the top-most failing aircraft system are further analyzed resulting in fifteen aircraft components ($n=15$) for the observed time interval – reliability analysis of the component is carried out (Table 3.10) using the models described in section 2.2 and 3.1 of this dissertation. Considering the risk of aviation incidents or accidents, the required level probability of failure-free operation of aircraft components is $p(T_{\Sigma})=0.95$.

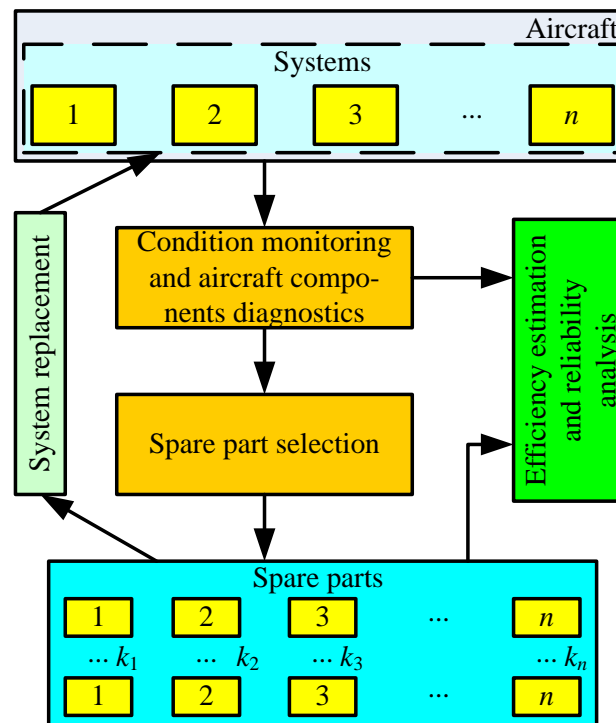

Fig. 3.24. The process of spare parts management

Table 3.10

Component failure rate of an aircraft navigation system.

№	Aircraft Component	λ	№	Aircraft Component	λ
1	Standby attitude indicator	0.0003185	9	Navigation control unit	0.0006370
2	Navigation receiver	0.0006370	10	TCAS Antenna	0.0006370
3	Transponder	0.0009555	11	TCAS Encoder	0.0003185
4	DME	0.0003185	12	GPS	0.0006370
5	Weather radar	0.0050962	13	EFIS	0.0006370
6	Automatic direction finder	0.0003185	14	EFIS display	0.0003185
7	Radio altimeter	0.0127406	15	EFIS display controller	0.0003185
8	Altitude control	0.0012740			

The aircraft component failure rate in Table 3.10 is the input data for the simulation and the optimal value of the spare parts that should be kept in the inventory is determined using the model described in section 2.5 – the flowchart is shown in Fig. 3.25. To determine the guaranteed probability of failure-free operations of aircraft components and the entire aircraft system, the basic theorems of probability theory is taken into consideration – the product of failure rate and observation interval is equal to average number of failures for the observed component. The simulation results are shown in Fig. 3.26 and Fig.3. 27.

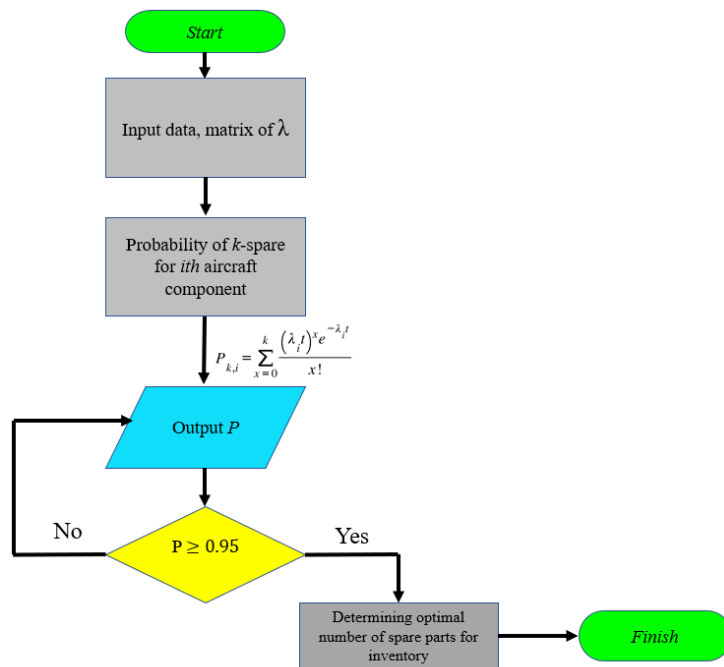

Fig. 3.25. Flowchart for determining optimal aircraft component spare parts for inventory

Figure 3.26 presents the dependence of guaranteed probability on number of possible failures for each aircraft component, and Fig. 3.27 shows the dependence for the whole aircraft system.

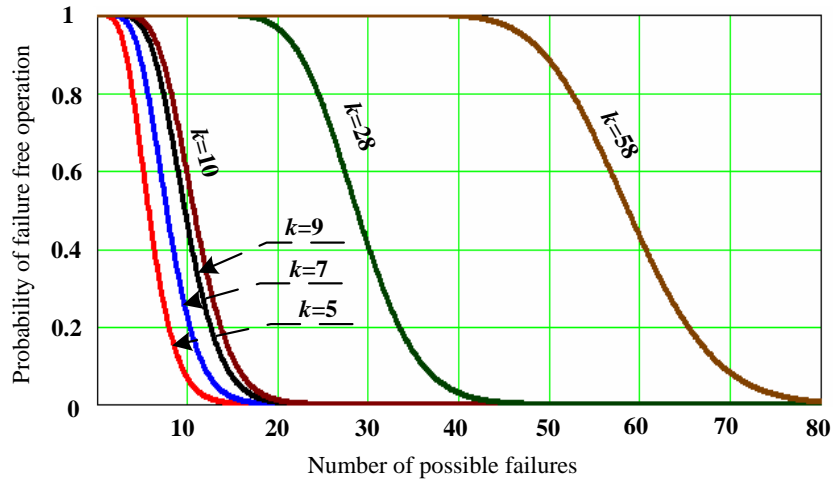

Fig. 3.26. Dependence of guaranteed probability of failure-free operation on number of possible failures for each aircraft component.

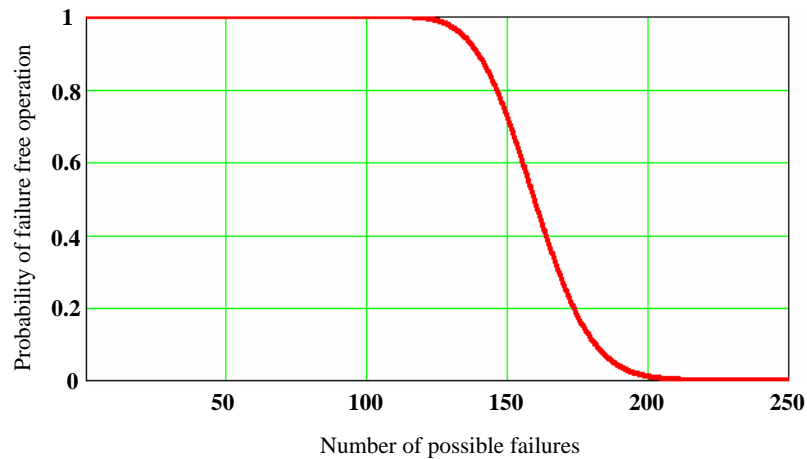

Fig. 3.27. Dependence of guaranteed probability of failure-free operation on number of possible failures for the whole aircraft system

According to the graph families in Fig. 3.26, the probability of failure-free operation dependence on number of possible failures for each aircraft component has the tendency of accelerated decrease in case of optimal value of spare parts increase. The dependence in Fig.

3.27 gives the conclusion that obtained spare parts demand is almost equal to a probability of one for failure-free operation of the whole aircraft system even in case of 120 failures in different systems. The values of optimal number spare parts of each component for the inventory is shown in Table 3.11.

Table 3.11

Simulation results for optimal spare parts planning.

№	Aircraft Component	λ	Optimal Number of Spare parts
1	Standby attitude indicator	0.0003185	5
2	Navigation receiver	0.0006370	7
3	Transponder	0.0009555	9
4	DME	0.0003185	5
5	Weather radar	0.0050962	28
6	Automatic direction finder	0.0003185	5
7	Radio altimeter	0.0127406	58
8	Altitude control	0.0012740	10
9	Navigation control unit	0.0006370	7
10	TCAS Antenna	0.0006370	7
11	TCAS Encoder	0.0003185	5
12	GPS	0.0006370	7
13	EFIS	0.0006370	7
14	EFIS display	0.0003185	5
15	EFIS display controller	0.0003185	5

Analysis of simulation results in Table 3.11 show that there are various spare parts demands for the components ranging from 5 (for the most reliable component) to 58 (for radio altimeter).

To analyse the accuracy of proposed method, simulation based on Monte Carlo method was performed [106]. The simulation procedure consists of the following steps: a) generation of two-dimensional array with exponentially distributed random numbers (times to failure) with failure rate for each i -th aircraft component (the first dimension corresponds to the sample size and is equal to optimal value of spare parts k_i , and the second dimension corresponds to the number of reiteration); b) calculation of the cumulative time of last failure; c) calculation of probability of failure-free operation for each aircraft component as the ratio of the number of times the cumulative time of last failure exceeded the observation interval to the number of

reiteration. The simulation results favourably coincided with required and calculated probability of failure free operation.

CONCLUSIONS

1. The models proposed in chapter 2 can form the framework for an optimized aircraft maintenance process which is predictive, and data driven. In this chapter daily aircraft operations data was applied to analyse and validate these models. A concise overview of predictive data-driven aircraft maintenance which justifies application of the models was given in section 3.1.
2. An analysis of the proposed model for reliability analysis of aircraft components, subsystems, systems, and structures given a large dataset was carried out in section 3.2.1 using real-life aircraft operations data. The χ^2 goodness-of-fit test was applied to the mathematical model to verify if it obeys the exponential distribution; the calculated χ^2 is less than the threshold value χ_{th}^2 hence the hypothesis for the exponential distribution law of mean time between failures of aircraft systems and structures is accepted with a significance level equal to 0.05.
3. An analysis of the proposed model for reliability analysis of aircraft components, subsystems, systems, and structures given a small dataset was carried out in section 3.2.2. The reliability parameter is determined based on the failure probability graph determined using Kazakyavicius equation. Using the resulting graphs, a visual goodness-of-fit test is carried out; the prognostic variables Q_1 and Q_2 are in accordance with the proposed model while x_i is based on the exponential distribution. The dots which do not connect for x_i visually proves that the model based on exponential distribution isn't suitable for a small dataset.
4. To determine which of the segmented regression models proposed in chapter 2 gives the most prediction accuracy, all models were tested using real-life aircraft operational

data from one of the aircrafts analysed in chapter 1; the matrix of unknown coefficients for each model is calculated using the ordinary least square method. To determine which of the three models gives the most precise prediction and at which optimal switching point m , analysis of the values of standard deviation σ for each value of $m=15-30$ is carried out; the least value of standard deviation σ is observed with the quadratic-quadratic segmented model when $m=16$ hence, this model is considered the most precise of the three proposed regression models for predicting failure of an aircraft component, subsystem, system, or structure. A pictorial representation of good, over- and underfitting in regression was used to compare all the resulting graphs of the proposed regression models; all the models were in accordance with good fitting.

5. Simulation analysis was carried out using the Monte Carlo method to prove the applicability of the models developed in chapter 2 for determining the optimal maintenance task interval using average operational cost as a measure of efficiency. Results prove that for the exponential model of time between failures, an optimal maintenance task interval which corresponds to a local minimum point on the graph of average operational cost per unit time vs maintenance task interval T_M does not exist; $T_{Mopt} \rightarrow \infty$. For the Erlang model, simulation results prove the existence of a “minimum” which corresponds to an optimal maintenance task interval. These results coincide with the analytical results in chapter 2 and further prove that it is possible to optimize maintenance task interval of aircraft systems using the Erlang model.
6. In chapter 2, a model is developed for determining the spare parts of aircraft components for non-repairable items and exponentially distributed times to failure. The quantity of spare parts is calculated using the required probability of failure-free operation and the estimated failure rate value obtained from real statistical data analysis. To analyse the accuracy of proposed model, simulation based on Monte

Carlo method was performed and results favourably coincided with required and calculated probability of failure free operation.

CHAPTER 4. A CONCISE METHODOLOGY FOR OPTIMIZING AIRCRAFT MAINTENANCE PROCESSES FOR CONTINUING AIRWORTHINESS OF AIRCRAFT IN NIGERIA

The operations phase of an aircraft life cycle is the longest, and despite the revenue aircrafts generate for an economy, the average operational cost may exceed the initial purchase price by as much as 10-20 times; Maintenance, Repair, and Overhaul (MRO) are estimated to be about 10-20% of operational costs [36, 44]. Furthermore, according to IATA, global maintenance, repair, and overhaul expenditure is expected to increase at an annual growth rate of 4.1%; therefore, airlines are constantly searching for ways to decrease these expenses without compromising on airworthiness [36]. This justifies the need for realism in mathematical models and the way optimization problem is formulated from the design phase of the aircraft lifecycle; system reliability, maintenance processes and cost must be considered. This chapter explains a concise methodology for the optimization of aircraft maintenance processes.

4.1. Justification of the proposed methodology for the optimization of aircraft maintenance processes for continuing airworthiness

In the West African regions, operational costs are still significantly higher than the global average figure, with aircraft operators spending over \$1 billion annually; Nigerian operations account for 75% of this figure [2]. This high figure is due to a lack of component overhaul MRO facilities that carry out heavy aircraft maintenance checks. Emerging MROs in Nigeria carry out checks on smaller aircraft up to the highest maintenance checks available. However, they are few, and the scope of work is mainly on helicopters and small fixed-wing aircraft. Therefore, most operators incur an additional cost of ferrying these aircraft overseas. Since scheduled and unscheduled line maintenance activities are still being carried out locally coupled with a significantly high global percentage allotted to aircraft maintenance, the global

aviation industry, especially West Africa, can move towards a modern approach by implementing Industry 4.0 solutions to optimize aircraft maintenance processes without compromising on safety and reliability.

Traditional maintenance actions including CM and PM are no longer able to address increased complexity of systems therefore a shift towards complex maintenance approaches can be implemented to ensure quality and reliability. Unscheduled maintenance results in costly delays and inconvenience to passengers. A significant reduction in the number of unscheduled maintenance tasks would transform the aviation industry. This may be enabled by an intelligent aircraft system that identifies and communicates component/system anomalies and self-diagnoses faults/failures, wear, software glitches, low fluids, etc. The era of big data mirrors the scientific computing revolution of the 1960s, which led to transformative engineering paradigms and allowed for the exact simulation of complex, engineered systems. This enabled prototyping of aircraft design using physics-based emulators that resulted in significant cost savings to aerospace manufacturers. Similarly, Machine Learning and (ML) and Artificial Intelligence (AI) algorithms are welcoming great technological developments in our generation and its' success is emerging in the aviation industry [12].

Despite the availability of many computer-aid solutions, aircraft maintenance planning is challenging due to the lack of optimization approaches for planning maintenance checks, and task and lack of realism in mathematical models and the way the maintenance optimization problem is formulated from the design phase. Existing maintenance optimization research focuses on modelling methods of system degradation process, repair threshold, maintenance cost and developments of heuristic algorithms for searching for the optimal decisions within the constraints. These methods are not the best solutions for the optimization of aircraft maintenance because: a) the current methods are considered static because optimization is based on fixed known maintenance scenarios and because of this, needs to be regularly modified because fundamental factors like component health state, repair cost, spare component orders vary with time. b) Inputs of these methods such as failure rate, average working time, aircraft availability requirement, etc. do not entirely cover other factors in

aircraft maintenance such as repair cost, PHM information, availability of spare components; these need to be jointly considered. c) the effect of long-term performance is rarely considered in current maintenance optimization research [37]. Hence, the primary contribution of this study is a simple and expandable four-step methodology (Fig 4.1) which consolidates approaches for reliability analysis of aircraft systems and structures, prediction of aircraft system faults/failures, optimization of aircraft maintenance task interval using average operational cost as a measure of efficiency and forecast of spare parts inventory for the optimization of aircraft maintenance processes. One of the needs for maintenance optimization arises from the necessity to minimize line maintenance activities that interrupt routine aircraft operations due to the frequency of their occurrence. Furthermore, frequent opening and closing of panels result in significant wear and tear, thereby reducing the inherent reliability of the aircraft [60].

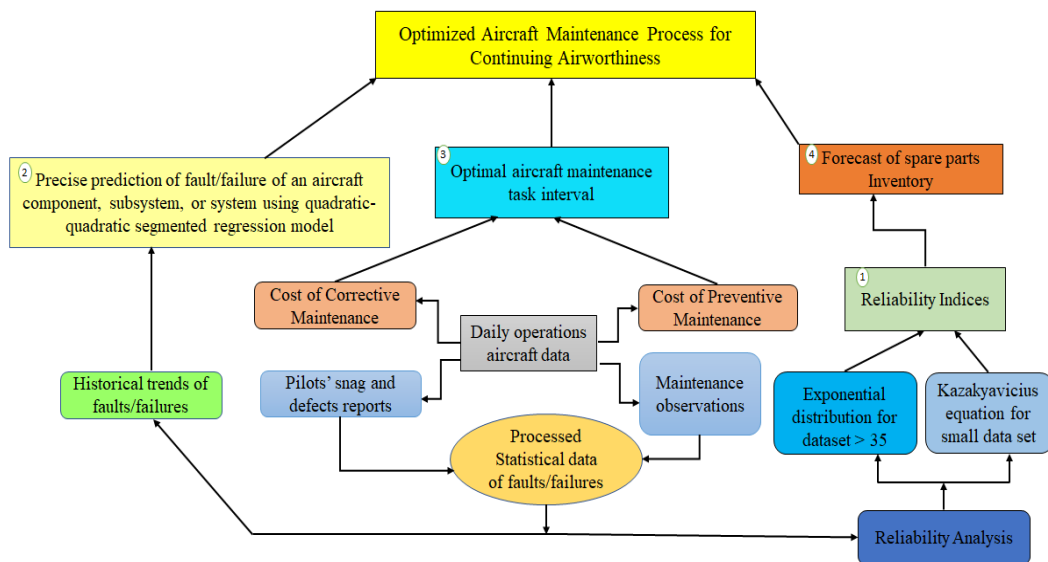

Fig 4.1. Methodology for the optimization of aircraft maintenance processes for continuing airworthiness of aircraft

The proposed four-step methodology takes advantage of latest data-driven predictive maintenance techniques based on ML, reliability, probability, and statistics theories and allows for optimized aircraft maintenance processes with reduced maintenance costs and downtime without compromising on safety. The outcomes of the proposed methodology will result in more predictable and efficient aircraft maintenance planning capability and can be implemented in the first three phases of aircraft lifecycle. As stated in previous chapters, the term ‘failure’ refers to faults and failures of aircraft components, subsystems, systems, or structures.

4.2. Overview of the proposed four-step methodology for optimizing aircraft maintenance processes for continuing airworthiness

In the aviation industry, health monitoring technologies are increasingly widespread. Various data-driven and model-based prognostics methods for remaining useful life estimation which aim at improving predictive maintenance for different types of components have recently appeared. However, the ability to pinpoint times to failure is not enough to yield better maintainability because scattered standalone interventions may increase total downtime [171]. Therefore, a four-step methodology was proposed in this dissertation (fig. 4.1). The methodology incorporates theoretical models based on daily aircraft operations data-driven predictive maintenance techniques based on ML, reliability, probability, and statistics theories.

The methodology launches the basis for further developments in terms of its future expansion, validation, and implementation. Its uniqueness resides in the fact that while most studies focus on individual components or systems, the proposed methodology takes into consideration all aircraft components and systems in a single framework. The models and algorithms proposed were validated using operational aircraft data and can be scaled to multiple systems without the need for specific domain knowledge. In addition, this data-driven approach is a more cost-effective alternative to physics-based modelling and can be utilized

for developing data-driven aircraft prognostics frameworks. An overview of the steps in the methodology is described in the following subsections.

4.2.1. Step 1 – Statistical simulation to determine reliability parameters

The evaluation of the reliability parameters of aircraft components, subsystem, systems, and structures is carried out using records of pilot reports and maintenance observations of fault/failures. The mean time between failures ($MTBF_i$), failure rates (λ_i), and failures per 1000 flight hours (K_{1000}) are calculated. For this step, two models depending on the size of dataset were developed and tested in the previous chapters. When dataset < 35 , Kazakyavicius equation is used to determine the failure probability but if the dataset > 35 , a model based on exponential distribution is used.

4.2.2. Step 2 – Statistical simulation to predict the flight hour at which a failure will occur in an aircraft component, subsystem, system, or structure

Wrong maintenance predictions and configuration strategies can lead to untimely support, flight delays, or AOG hence this step demonstrates a correlation between the failure of the system or component and the flight hour at which it will occur. As demonstrated in chapter 3, quadratic-quadratic segmented regression model is the model with the least standard deviation for predicting the occurrence of failures using daily aircraft operations data. This step provides high precision predictions for future unprecedented maintenance interventions using operational data that are generated and stored but often disregarded.

4.2.3. Step 3 – Estimate the optimal maintenance task interval using average operational cost as a measure of efficiency

Most literature on optimal maintenance task models use the maintenance cost rate as an optimization criterion but overlook the reliability performance. Reducing the system maintenance cost rate does not imply that the system reliability performance is optimized in terms of cost, specifically for multicomponent systems. Minimal maintenance cost is sometimes associated with reduced system reliability measures; this is one of the outcomes of having different components in the system, which may have various maintenance costs and different importance to the system. Considering an aircraft consists of various systems and components, an optimal maintenance task interval should always consider both the maintenance cost and reliability [172]; this is the motivation for introducing the cost-adjusted measure to determine the optimal maintenance task interval. Therefore, in this step, the estimation of the optimal maintenance task interval of the aircraft component or system is carried out using average operational cost as a measure of efficiency. In chapter 2, two reliability models, the exponential and Erlang models of time between failures were analyzed for optimality using average operational cost per unit time as the efficiency indicator. Analytical equations and statistical simulations of the PDFs for the exponential model of TBF show that an optimal aircraft maintenance task interval does not exist because no minimum and optimal maintenance task interval tends to infinity. For the PDF of the Erlang model for TBF, a minimum exists for average operational cost per unit time. The optimal maintenance task interval values obtained according to analytical equations, numerical optimization, and simulation results are approximately the same. Therefore, the Erlang model can estimate the optimal maintenance task intervals for aircraft systems and components.

4.2.4. Step 4 – Forecast the spare parts inventory for aircraft operations

Standby redundancy technique system has been widely used to improve reliability and prolong the operating time of systems. In this technique, some spare parts are provided for the operating component i.e., if an operating component fails, the spare part is switched on for replacement. Standby redundancy technique includes hot standby, warm standby, and cold standby. However, it is common knowledge that spare parts performance deteriorate over time in hot standby, warm standby and even cold standby. Spare parts can also can suddenly fail due to external shocks. Degradation in performance of spare parts which typically leads to storage failure is because of deteriorations which occur over time due to inner mechanism and imperfect storage. Overstocking spare parts can result in significant unnecessary inventory costs and storage failure which result in waste. On the other hand, shortage of spare parts may result in downtime and loss of revenue [173]. Spare parts inventories serve maintenance planning; an excess of spare parts inventory results in a high holding cost and impedes cash flows, while lack of spare parts can lead to costly flight delays or cancellations which negatively impact airline performance [72]. Currently the global civil aviation industry spends approximately \$50 billion in spare parts, which accounts for 75% of inventory funds. However, utilization and turnover rates are low and only 25% are used hence there is a problem of excessive backlog. On the other hand, wrong spare parts forecast can lead to flight delays and AOGs [71]. Therefore, an accurate or near accurate forecast of spare sparts inventory can significantly optimize aircraft maintenance processes – this is the final step of the proposed methodology and is carried out using the statistical model described in chapter 2 and 3.

4.3 Technique for the calculation of reliability indices of aircraft systems and components

When the dataset > 35 , the statistical simulation steps for reliability analysis are as follows:

- 1) Input the matrix of the processed statistical data of failures
- 2) Computation of time series of observed failures D_k

$$D_k = \sum_{j=0}^k C_j$$

- 3) Determination of time moment F at which the i -th failure occurs is defined as follows

$$F_{0,k} = \begin{cases} D_k & \text{if } E_k \leq 0 \\ 0, & \text{otherwise} \end{cases} ; \quad F_{i,k} = \begin{cases} D_k & \text{if } B_{i-1} < E_k \leq B_i \\ 0, & \text{otherwise} \end{cases}$$

- 4) Formulation of one-dimensional array A_i

$$A_i = \begin{cases} s \leftarrow 0 & \text{for } k \in 0..N-1 \\ \text{if } F_{i-1,k} \neq 0, & a_s \leftarrow F_{i-1,k} \\ s \leftarrow s + 1 \end{cases}$$

- 5) Plotting of the PDFs
- 6) Analysis of PDFs to determine λ_i , $MTBF_i$ and K_{1000}

If a small dataset i.e., < 35 is generated then the reliability analysis is carried out as follows:

1. Matrix of processed statistical data of failures x_i
2. Determine the number of observations for tails approximation $j=1.5\sqrt[3]{x}$.
3. Calculate the values of the lower (y_i lower) and upper tail (y_i upper)

$$y_i = \ln \frac{x_i^{(order)}}{Med}$$

4. Calculate the sums of first (δ_1) and last (δ_2) random variables

$$\delta_1 = \sum_{i=1}^j y_i; \quad \delta_2 = \sum_{i=n-j}^n y_i$$

5. Calculation of the corresponding quantiles of the standard normal distribution after the transformation in accordance with Kazakyavicius equation

$$K_i = 2.0637 \left(\ln \left(\frac{1}{1-p_i} \right) - 0.16 \right)^{0.4274}$$

6. Estimation of the products of variation coefficient and the sum of corresponding quantiles

$$\delta_{K \min} = V \sum_{i=1}^j K_i; \quad \delta_{K \max} = V \sum_{i=n-j}^n K_i$$

7. Determination of the transformation basis for the minimum (β_1) and maximum (β_2)

$$\beta_1 = e^{\frac{\delta_1}{\delta_{K \min}}}; \quad \beta_2 = e^{\frac{\delta_2}{\delta_{K \max}}}$$

8. Calculation of the basis function $F_1(K_i)$ and $F_2(K_i)$

$$F_1(K_i) = \frac{\beta_1 e^{-K_i} + \beta_2 e^{K_i}}{e^{-K_i} + e^{K_i}},$$

$$F_2(K_i) = \beta_1 + b(K_i + K_{sw})_+ - b(K_i - K_{sw})_+$$

9. Calculation of prognostic variables Q_1 and Q_2

$$Q_1 = Med. F_1^{K_i V}$$

$$Q_2 = Med. F_2^{K_i V}$$

10. Plotting of graphs using values of x_i , Q_1 and Q_2

11. Plotting of failure probability graph

$$p(x) = -e^{\left[\left(\frac{x}{2.0637} \right)^{0.4274} + 0.16 \right] + 1}$$

12. Using the graphs determine the values of the failure probability and reliability

4.4 Technique for predicting the flight hour at which a failure will occur in aircraft component or system

- 1) Input the matrix of processed statistical data of failures i
- 2) Predict the time moment of the next failure of the aircraft system or component i

$$Y_3(X) = \beta_{0,3} + \beta_{1,3} X + \beta_{2,3} X^2 + \beta_{3,3} (X - m) \phi(X - m) + \beta_{4,3} (X - m)^2 \phi(X - m)$$

- 3) Determine the coefficients of the model

$$\begin{bmatrix} \beta_{0,3} \\ \beta_{1,3} \\ \beta_{2,3} \\ \beta_{3,3} \\ \beta_{4,3} \end{bmatrix} = \begin{bmatrix} n & \sum_{i=1}^n i & \sum_{i=1}^n i^2 & \sum_{i=m}^n (i-m) & \sum_{i=m}^n (i-m)^2 \\ \sum_{i=1}^n i & \sum_{i=1}^n i^2 & \sum_{i=1}^n i^3 & \sum_{i=m}^n [i(i-m)] & \sum_{i=m}^n [i(i-m)^2] \\ \sum_{i=1}^n i^2 & \sum_{i=1}^n i^3 & \sum_{i=1}^n i^4 & \sum_{i=m}^n [i^2(i-m)] & \sum_{i=m}^n [i^2(i-m)^2] \\ \sum_{i=m}^n (i-m) & \sum_{i=m}^n [i(i-m)] & \sum_{i=m}^n [i^2(i-m)] & \sum_{i=m}^n (i-m)^2 & \sum_{i=m}^n (i-m)^3 \\ \sum_{i=m}^n (i-m)^2 & \sum_{i=m}^n [i(i-m)^2] & \sum_{i=m}^n [i^2(i-m)^2] & \sum_{i=m}^n (i-m)^3 & \sum_{i=m}^n (i-m)^4 \end{bmatrix}^{-1} \begin{bmatrix} \sum_{i=1}^n T_i \\ \sum_{i=1}^n (T_i i) \\ \sum_{i=1}^n (T_i i^2) \\ \sum_{i=m}^n [(i-m)T_i] \\ \sum_{i=m}^n [(i-m)^2 T_i] \end{bmatrix}$$

- 4) Calculate the value of the optimal switching point \mathbf{m} for based on the corresponding least value of standard deviation σ

$$\sigma = \sqrt{\frac{1}{n-l} \sum_{i=1}^n (T_i - \hat{Y})^2}$$

- 5) Based on the values of \mathbf{m} and σ , the optimal value of the switching point is calculated. This value is input into the model alongside the corresponding coefficients; this is considered the most precise mathematical model for predicting the flight hour at which a failure is likely to occur in the observed aircraft system or component.

4.5 Estimation of the optimal aircraft maintenance task interval

The step-by-step procedure for determine the optimal aircraft maintenance task interval is as follows:

- 1) Define the Erlang PDF as

$$f(t) = \lambda^2 t e^{-\lambda t}, \quad \lambda > 0, \quad t > 0$$

- 2) Calculation of the PDF for the duration of n -th failure for any given PDF $f(t)$ for TBF using the theory of functional transformation of random variables

$$f_n(t) = \int_{-i\infty}^{i\infty} \left(\int_0^{\infty} f(t) e^{iwt} dt \right)^n dw$$

- 3) Define the probability of occurrence of n failures during the observed time interval using CDF

$$F_n(t) = \int_0^t f_n(t) dt$$

- 4) Determine the distribution of number of failures during the observed time interval

$$P(n/t) = F_n(t) - F_{n+1}(t) = \int_0^t f_n(t) dt - \int_0^t f_{n+1}(t) dt = \frac{(\lambda t)^{2n+1}}{(2n+1)!} e^{-\lambda t} + \frac{(\lambda t)^{2n}}{(2n)!} e^{-\lambda t}$$

Efficiency of the maintenance processes is calculated as

$$E(C/T_M) = \frac{E(n/T_M)C_R + C_M}{T_M}$$

- 5) Estimation of the expected number of faults/failures during the observed time interval T_M

$$E(n/T_M) = \sum_{n=1}^{\infty} nP(n/T_M) = \sum_{n=1}^{\infty} \left(n \frac{(\lambda T_M)^{2n+1}}{(2n+1)!} + \frac{(\lambda T_M)^{2n}}{(2n)!} \right) e^{-\lambda T_M} = \frac{\lambda T_M}{2} + \frac{e^{-2\lambda T_M}}{4} - \frac{1}{4},$$

$$E(C/T_M) = \frac{(2\lambda T_M + e^{-2\lambda T_M} - 1)C_R + 4C_M}{4T_M}$$

- 6) Analyze for optimum value

$$\frac{dE(n/T_M)}{dt} = \frac{-2\lambda C_R T_M e^{-2\lambda T_M} - C_R e^{-2\lambda T_M} + C_R - 4C_M}{T_M^2},$$

$$-2\lambda C_R T_M e^{-2\lambda T_M} - C_R e^{-2\lambda T_M} + C_R - 4C_M = 0,$$

$$e^{-2\lambda T_M} \approx 1 - 2\lambda T_M,$$

$$-2\lambda C_R T_M + 4\lambda^2 C_R T_M^2 - C_R + 2\lambda C_R T_M + C_R - 4C_M = 0,$$

$$\lambda^2 C_R T_M^2 - C_M = 0$$

- 7) Determine the optimal maintenance task interval $T_{M opt}$

$$T_{M opt} = \sqrt{\frac{C_M}{\lambda^2 C_R}}$$

c_R is CM cost, c_M is PM cost, λ is the failure rate.

4.6 An optimized approach for forecasting spare parts inventory of aircraft operations

1. Monitor the condition of the aircraft systems/structures using the methodology for reliability analysis (4.2) and prognostic health monitoring.
2. Calculate the cumulative probability of the maximum consumption of spare parts x

$$F(x) = \sum_{j=0}^x \frac{(\lambda T_{\Sigma})^j}{j!} e^{-\lambda T_{\Sigma}}$$

3. The value of $F(x)$ corresponds to the required probability of failure-free operation $p_i(T_{\Sigma})$ for each aircraft system or component; $p(T_{\Sigma})$ is estimated using the probability multiplication theorem

$$p(T_{\Sigma}) = \prod_{i=1}^n p_i(T_{\Sigma})$$

$$\sqrt[n]{p(T_{\Sigma})} = \sum_{j=0}^{k_i} \frac{(\lambda_i T_{\Sigma})^j}{j!} e^{-\lambda_i T_{\Sigma}}$$

4. Determine the values of $p_i(T_{\Sigma})$ using the graphical method of plotting the graph families for $F(x)$.
5. Estimate the optimal number of spare parts; this value is an abscissa of the intersection point of the corresponding graph for the calculated failure rate and the required value of the probability of failure-free operation.

4.7 Advantages of the proposed four-Step methodology for the optimization of aircraft maintenance processes for continuing airworthiness

Maintenance optimization in practical cases focuses on determining what actions are mandatory and when to apply them mathematically, the problem is a sequential decision-making problem in an uncertain environment and its resolution is challenging. Much research effort especially in the structural and reliability engineering community has been dedicated to finding optimal inspection and maintenance strategies; formulation of the problem and suitability of various resolution approaches may vary based on the application considered. The selection of the most cost-effective strategy is rarely straightforward [174]; hence the proposed methodology provides a concise step by step easy-to-use approach for optimizing aircraft maintenance for continuing airworthiness. The application of this methodology is expected to yield significant benefits in choosing the most appropriate maintenance intervention based on objective criteria, in estimating the likelihood of nonscheduled maintenance and in estimating the number of spare components needed for both scheduled and nonscheduled maintenance.

Higher Reliability, Availability, Maintainability, and Safety (RAMS) standard is the goal for aircraft operations. Optimal predictive data-driven maintenance scheduling and rescheduling is a key element for the actualization of the RAMS goal – the proposed methodology provides the framework for achieving this. It can also be implemented in the design and manufacturing phase of aircraft life cycle because built-in prognostic capability for scheduling maintenance results in reduced maintenance delays and increase in aircraft availability and higher operational readiness level. Furthermore, implementing prognostic-based maintenance scheduling requires different state-of-the-art technologies and methodologies including an efficient data processing and management system, advanced data mining and computing techniques, sophisticated prognostic algorithms, as well as optimization algorithms for solving the maintenance scheduling problem of complex and large-scale optimization formulations [47] – the easy to use proposed methodology can be implemented to optimize prognostic-based maintenance strategy.

The proposed methodology provides a framework for maximizing the utilization of daily aircraft operations data which is often stored but largely disregarded. The insights can be used to estimate the probability of aircraft component failure, estimate an optimal maintenance task interval, and plan maintenance actions accordingly. As shown in Fig 4.2, this approach is expected to reduce waste which arises because of early maintenance and failure costs connected with late maintenance actions.

The effectiveness of the proposed method is proven by analytical and numerical examples. The proposed models and algorithm have both good experimental effect and theoretical convergence. Their performance was demonstrated with a comprehensive computational experiment using real life data of a aeroplanes and helicopters operating in Nigeria; the results of the analysis in Chapter 3 show that the proposed models and algorithms are effective for an optimizing aircraft maintenance for all three phases of aircraft life cycle. Hence, it can be implemented not just in Nigeria, a country in the west African region but also globally while considering safety and airworthiness standards.

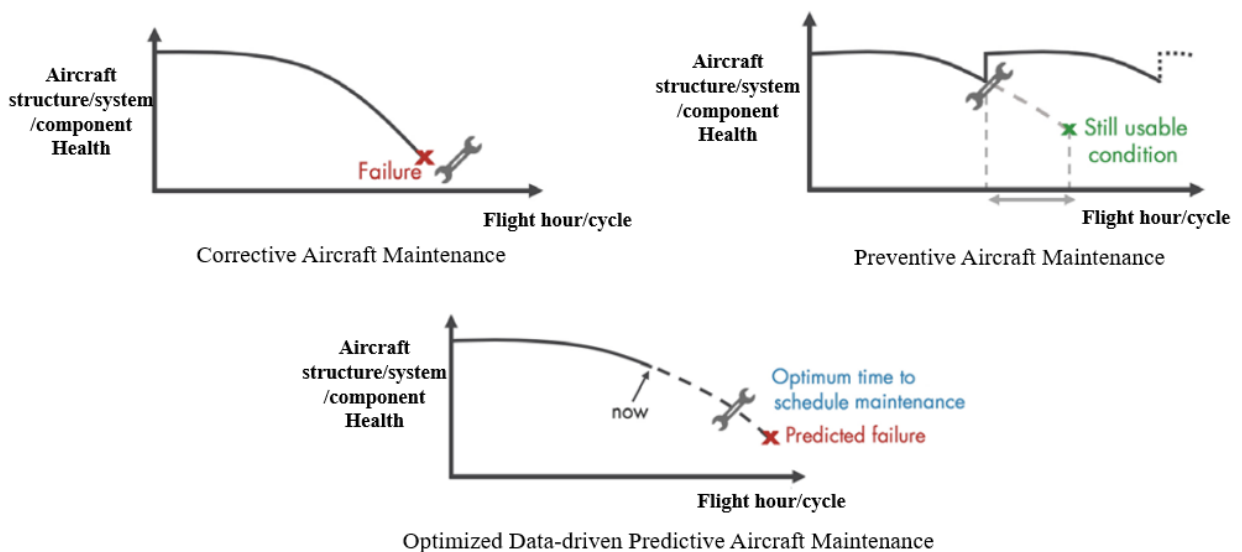

Fig. 4.2. An illustration of the advantages of an optimized data-driven predictive aircraft maintenance

The effectiveness of the proposed method is proven by analytical and numerical examples. The proposed models and algorithm have both good experimental effect and theoretical convergence. Their performance was demonstrated with a comprehensive computational experiment using real life data of a aeroplanes and helicopters operating in Nigeria; the results of the analysis in Chapter 3 show that the proposed models and algorithms are effective for an optimizing aircraft maintenance for all three phases of aircraft life cycle. Hence, it can be implemented not just in Nigeria, a country in the west African region but also globally while considering safety and airworthiness standards.

An optimized data-driven aircraft maintenance approach using the proposed methodology can result in reduced aircraft downtime, more targeted maintenance, increased steady state availability of aircraft, reduced no faults found and more efficient inventory management. The insight from implementing the proposed methodology allows engineers and technicians to take a proactive approach to aircraft maintenance planning by addressing real issues before they create problems thereby maximizing availability and reliability of aircraft. Additionally, spare parts procurement, ordering and decision making is significantly improved with increased accuracy in forecasting and usage.

CONCLUSIONS

1. Traditional maintenance actions including CM and PM are no longer able to address increased complexity of systems therefore a shift towards complex maintenance approaches on the basis of Industry 4.0 solutions can be implemented to optimize aircraft maintenance processes without compromising on safety and reliability.
2. Existing maintenance optimization research models are not the best solutions for the optimization of aircraft maintenance due to: a) they are considered static because optimization is based on fixed known maintenance scenarios which requires regular modification due to fundamental factors such as component health state, repair cost,

spare component orders which vary with time. b) Inputs of these models such as failure rate, average working time, aircraft availability requirement, etc. do not entirely cover other factors in aircraft maintenance such as repair cost, PHM information, availability of spare components; these need to be jointly considered. c) the effect of long-term performance is rarely considered.

3. Given the drawbacks of existing maintenance optimization models, the primary contribution of this study is a simple and expandable four-step methodology which consolidates approaches for reliability analysis of aircraft systems and structures, prediction of aircraft system faults/failures, optimization of aircraft maintenance task interval using average operational cost as a measure of efficiency and forecast of spare parts inventory for the optimization of aircraft maintenance processes. The proposed four-step methodology takes advantage of latest data-driven predictive maintenance techniques based on ML, reliability, probability, and statistics theories and allows for optimized aircraft maintenance processes with reduced maintenance costs and downtime without compromising on safety.
4. The proposed methodology provides a framework for maximizing the utilization of daily aircraft operations data which is often stored but largely disregarded. The insights can be used to estimate the probability of aircraft component failure, estimate an optimal maintenance task interval, and plan maintenance actions accordingly thereby resulting in more predictable and efficient aircraft maintenance planning capability. Its' application is expected to yield significant benefits in choosing the most appropriate maintenance intervention based on objective criteria, in estimating the likelihood of unscheduled maintenance and in estimating the number of spare components needed for both scheduled and unscheduled maintenance. Furthermore, insights gleaned from its usage can be beneficial in solving the maintenance optimization problem from the design phase of the aircraft life cycle.

RESEARCH CONCLUSIONS

In this dissertation, using Nigerian aircraft operations as a case study, the scientific task of developing statistical and mathematical models for the optimization of aircraft maintenance processes was carried out. The models and algorithms proposed provide a framework for maximizing the utilization of daily aircraft operations data, which is often stored but primarily disregarded. The models are further consolidated into a four-step methodology expected to reduce waste that arises because of early maintenance and failure costs connected with late maintenance actions. The following key results of the research were obtained:

1. The operations phases of the aircraft lifecycle cost 10-20 times the design and manufacture phases; this justifies the need for realism in mathematical models and the way optimization problem is formulated; system reliability, maintenance processes, and cost must be considered from the first phase of the aircraft lifecycle.

2. In-depth analysis of aircraft operations in Nigeria, a country in West Africa, to understand the reason for the significantly higher than average cost of aircraft maintenance despite a post-COVID-19 pandemic annual growth rate of 43.41% and 57.61% respectively for domestic and international passenger traffic. Research surveys using personnel working with aircraft operators and regulators in Nigeria revealed many problems. This justifies a need for operators in Nigeria and globally to adopt an optimized data-driven predictive maintenance process based on industry 4.0 principles. This research was devoted to developing these models and algorithms using real daily operations aircraft data from ERJ 135, ATR 42-300, MD-83 , S-76, and S-92 operating in Nigeria.

3. RCM was initially designed for use in the aircraft industry; It allows for the calculation of system reliability considering different kinds of maintenance checks and their intervals, thereby providing information for optimizing operational cost, safety, and reliability. However, analysis reveals significant research in the development of models for RCM strategies. However, there is a gap in mathematical models to determine the characteristic reliability of aircraft systems for optimizing aircraft maintenance. The need for such models

justifies the development of statistical simulation models in this study to provide an in-depth understanding of the interaction between reliability levels and historical trends of faults and failures in aircraft operations. Depending on the sample size, 2 statistical simulation models which can significantly improve the existing framework of RCM in aviation were developed.

4. To significantly reduce the occurrence of unscheduled aircraft maintenance tasks, an accurate or near-accurate prediction of the occurrence of faults/failures is needed. In this research, an initial attempt to carry out failure prediction of aircraft components, subsystems, systems, and structures using daily aircraft operations data was explored and validated. The model for this prediction was developed using a combination of statistical and ML techniques; computational evaluation demonstrates its applicability to aircraft operations.

5. Line maintenance activities interrupt routine aircraft operations due to the frequency of their occurrence. Additionally, they result in frequent opening and closing of panels which lead to significant wear and tear, thereby reducing the inherent reliability of the aircraft. This justifies the need for an optimal aircraft maintenance task interval, and significant research has been carried out. However, existing models use maintenance cost rate as an optimization criterion but overlook the reliability performance, which isn't ideal for aircraft operations; both maintenance cost and reliability should be considered. This justifies the development of a model in this study to determine optimal aircraft maintenance task interval using average operational cost per unit time. The proposed model quantifies the cost and benefits of maintenance to obtain an optimum balance between both.

6. Spare parts account for 60-80% of maintenance expenditure, and 80% of downtime is caused by 20% of equipment. Excessive spare parts lead to high holding costs and impede cash flows. In contrast, inadequate spare parts can result in expensive flight cancellations or delays, negatively impacting airline performance. The global civil aviation industry currently stores approximately \$50 billion in spare parts, which accounts for approximately 75% of airlines' inventory funds and 25% of working capital. However, the turnover and utilization rate of most civil aircraft spare parts are low, only 25% are used, and even more, there is a problem of excessive backlog. These justify the need for an optimal

forecast of spare parts demand (sufficiency). The proposed models in this dissertation were developed using a combination of analytical approaches which focus on the interaction between failure rates and spare parts inventory. The models are tied to failure rates and the probability of failure-free operations is determined using real aircraft data; The failure rate gives reliable information for an accurate forecast of spare parts demand.

7. The ability to pinpoint times of failure is not enough to yield better maintainability because scattered standalone interventions may increase total downtime. Therefore, the models for reliability analysis, prediction of failure, determining optimal maintenance task interval, and forecasting spare parts demands were consolidated into a four-step methodology, which launches the basis for further developments in terms of its future expansion, validation, and implementation. Its uniqueness resides in the fact that while most studies focus on individual components or systems, the proposed methodology takes into consideration all aircraft components and systems in a single framework. Furthermore, the models and algorithms proposed were validated using operational aircraft data and can be scaled to multiple systems without needing specific domain knowledge.

8. The maintenance review board reports of any new aircraft is developed without in-service experience, resulting in the tendency to be conservative in the decision-making process. As the aircraft accumulates service experience, task intervals should be adjusted to follow the results of professional analysis of actual in-service data because intervention/replacement intervals are often not seriously based on actual system reliability; this results in maintenance costs that are higher than optimum. The proposed four-step methodology can be applied during the design and manufacturing phase of the aircraft life cycle as well as during the operations phase as the aircraft accumulates service experience.

9. The novel four-step methodology proposed in this study is a data-driven approach that provides a general theoretical framework for optimizing aircraft maintenance processes for continuing airworthiness. These proposed models and algorithms can be translated into solutions for cost-effective and efficient aircraft operations. Practical and beneficial applications of this approach include a reduced number of NFFs because of preventive

maintenance actions, an optimal maintenance task interval, and reduced downtime due to a lack of spare parts. Based on existing literature and an industry example, the proposed methodology is considered a novel theoretical framework for performance-centered aircraft maintenance, which considers the operational performance and the condition of an aircraft component or system. The core concepts of the theories applied were explained in the dissertation.

10. Based on existing knowledge and aircraft maintenance experience, the models and algorithms in the proposed methodology for the optimization of aircraft maintenance processes for continuing airworthiness will be one of the prerequisites for the application of data-driven aircraft maintenance. In addition, these concepts can be implemented in the design and manufacturing phases of the aircraft life cycle to implement higher levels of inherent reliability and initial airworthiness.

REFERENCES

1. National Bureau of Statistics. Air Transportation Data (Full Year 2021). URL: <https://nigerianstat.gov.ng/elibrary/read/1241160>.
2. Lawani M. Airlines choking on high repair, fuel costs — REPORT. Vanguard News Nigeria. 2021. URL: <https://www.vanguardngr.com/2021/08/airlines-choking-on-high-repair-fuel-costs-report/>.
3. Hodkiewicz M., Lukens S., Brundage M. P., and Sexton, T. Rethinking maintenance terminology for an industry 4.0 future. *International Journal of Prognostics and Health Management*. 2021. Vol. 12 No. 1. doi.org/10.36001/ijphm.2021.v12i1.2932.
4. van Staden H. E., Depre L., and Boute R. N. A dynamic “predict, then optimize” preventive maintenance approach using operational intervention data. *European Journal of Operational Research*. 2022. Volume 302 (3), P. 1079-1096. doi.org/10.1016/j.ejor.2022.01.037.
5. Livne E. Reflections on Active Aeroelastic Control and the Multidisciplinary Design Optimization of Aircraft. *33rd Congress of The International Council of the Aeronautical Sciences Enoch Thulin Lecture for Innovation in Aeronautics*. 2022.
6. Sushchenko O.A., Golitsyn V.O. Data processing system for altitude navigation sensor. *Proceedings of IEEE 4th International Conference on Methods and Systems of Navigation and Motion Control*, Ukraine. 2016. P. 84-87. doi.org/10.1109/MSNMC.2016.7783112.
7. Kharchenko V.P., Kuzmenko N.S., Ostroumov I.V. Identification of Unmanned Aerial Vehicle Flight Situation. *Proceedings of IEEE 4th International Conference on Actual Problems of Unmanned Air Vehicles Developments*, Kyiv, Ukraine. 2017. P. 116-120. doi.org/10.1109/APUAVD.2017.8308789.
8. Prokopenko I. G., Migel S. V., Prokopenko K. I. Signal Modeling for the Efficient Target Detection Tasks. *Proceedings of International Radar Symposium*, Dresden, Germany. 2013, Vol. II. P. 976-982.
9. Shmelova T., Sikirda Yu., Kasatkin M. Applied Artificial Intelligence for Air Navigation Sociotechnical System Development. *Proceedings of ICT in Education, Research and*

Industrial Applications. Integration, Harmonization and Knowledge Transfer; Part V: Posters, Kherson, Ukraine. 2019. P. 470-475.

10. Shmelova T., Sikirda Yu., Scarponi C., and Chialastri A. Deterministic and Stochastic Models of Decision Making in Air Navigation Socio-Technical System. *Proceedings of ICT in Education, Research and Industrial Applications. Integration, Harmonization and Knowledge Transfer; Part III: Theory of Reliability and Markov Modelling for Information Technologies (TheRMIT 2018)*, Kyiv, Ukraine. 2018, Vol. II. P. 649-656.
11. Solomentsev O., Zaliskyi M., Herasymenko T., Kozhokhina O., and Petrova Y. Efficiency of Operational Data Processing for Radio Electronic Equipment. *Aviation*. 2019, Vol. 23 (3). P. 71-77. doi.org/10.3846/aviation.2019.11849
12. Brunton S.L., Nathan Kutz J., Manohar K., Aravkin A.Y., Morgansen K., Klemisch J., Goebel N., Buttrick J., Poskin J., Blom-Schieber A.W. and Hogan T. Data-driven aerospace engineering: reframing the industry with machine learning. *AIAA Journal*,. 2021, 59(8). P. 2820-2847.
13. Schmidt M., Ploetner K.O., Öttl G., Isikveren A.T. and Hornung M. Scenario-based life-cycle cost assessment of future air transport concepts. *International Journal of Aviation Management*. 2015, 2(3/4). P. 167-182.
14. Nigeria Civil Aviation Authority (NCAA). About NCAA. Extracted July 2020 URL: <https://ncaa.gov.ng/about/about-ncaa/>
15. Nigeria Civil Aviation Regulations (Nig.CARs) - Part 5. Extracted July 2020. URL: <https://ncaa.gov.ng/documents/regulations/nigeria-civil-aviation-regulations-nig-cars-part-5/>.
16. Gratton G. Initial airworthiness: Determining the acceptability of new airborne systems. *Springer International Publishing, Switzerland*. 2015. 319 p.
17. Coutu A., Alblowi M. ICAO Doc 9760 (Airworthiness Manual) 3rd Edition. 2014. 166 p.
18. Part M Continuing Airworthiness Managements Organization. International Civil Aviation Organization (ICAO) Documents. Extracted July 2020. URL:

www.icao.int/MID/Documents/2019/ACAO-ICAO%20Airworthiness/Session%207%20Part%20M%20CAMO%20final.pdf

19. Ren, H., Chen, X. and Chen, Y., 2017. Reliability based aircraft maintenance optimization and applications. *Shanghai Jiao Tong University Press, Published by Elsevier Inc.* 2017. 237 p.
20. European Committee for Standardization (CEN). EN 13306:2017 Maintenance Terminology. European Standard, Brussels.
21. Halm J., Hechtenberg K.V. and Kolander W. System and method for diagnosing aircraft components for maintenance purposes. *EADS Deutschland GmbH and Airbus Operations GmbH.* 2006, U.S. Patent 7,050,894.
22. Marwedel S., Reitmann J. and Poupard M. Platform for aircraft maintenance services. *Airbus Operations GmbH.* 2013, U.S. Patent Application 13/508,515.
23. Huet J.M., Besseau S., Maillard B. and Michaud F. Method and computer program for the maintenance aid of aircraft equipment. *Airbus Operations SAS and Airbus SAS.* 2017, U.S. Patent 9,767,413.
24. Hinsch M. Industrial aviation management: A primer in European design, production and maintenance organisations. *Springer-Verlag GmbH Germany.* 2019. 345 p.
25. Celikmih K., Inan O. and Uguz H. Failure prediction of aircraft equipment using machine learning with a hybrid data preparation method. *Scientific Programming.* 2020, Article ID 8616039. doi.org/10.1155/2020/8616039
26. Dhillon B.S. 2002. Engineering maintenance: a modern approach. CRC Press LLC. 2002. 222p.
27. Sharma A., Yadava G.S. and Deshmukh S.G. A literature review and future perspectives on maintenance optimization. *Journal of Quality in Maintenance Engineering.* 2011, Vol. 17 No. 1. P. 5-25.
28. Niu G., Yang B.S. and Pecht M. Development of an optimized condition-based maintenance system by data fusion and reliability-centered maintenance. *Reliability engineering & system safety.* 2010. 95(7). P. 786-796.

29. Dhillon B.S. Maintainability, maintenance, and reliability for engineers. Taylor & Francis Group, LLC. 2006. 221p.
30. Nigeria Civil Aviation Regulations (Nig.CARs) - Part 9. Extracted July 2020. URL: <https://ncaa.gov.ng/documents/regulations/nigeria-civil-aviation-regulations-nig-cars-part-9/>.
31. ATR 42-300/320 Series Maintenance Programme. 2021, Issue 5.
32. QID 927-S76C++ Maintenance Programme. 2018, Issue 2.
33. Maisonneuve P.L., Glade M., Ghelam S. and Lyonnet P. Method of organizing aircraft maintenance. *Eurocopter France SA*. 2013, U.S. Patent 8,478,477.
34. A'Hearn F.W. The MSG-2 Commercial Airline Concept: A Department of Defense Program for Reliability-Centered Maintenance. *Defense Systems Management College, Fort Belvoir, Virginia*. 1977. 73 p
35. ATA MSG-3 Operator/Manufacturer Scheduled Maintenance Development. *Air Transport Association of America, Inc*. 2002, Revision 2002.1. 92 p
36. Shaukat S., Katscher M., Wu C.L., Delgado F. and Larrain, H. Aircraft line maintenance scheduling and optimisation. *Journal of Air Transport Management*. 2020 (89). P. 101914.
37. Hu Y., Miao X., Zhang J., Liu J. and Pan E. Reinforcement learning-driven maintenance strategy: A novel solution for long-term aircraft maintenance decision optimization. *Computers & Industrial Engineering*. 2021(153). P. 107056.
38. Callewaert P., Verhagen W.J. and Curran R. Integrating maintenance work progress monitoring into aircraft maintenance planning decision support. *Transportation Research Procedia*. 2018(29). P. 58-69.
39. Verhoeff M., Verhagen W.J.C. and Curran R. 2015. Maximizing operational readiness in military aviation by optimizing flight and maintenance planning. *Transportation Research Procedia*. 2015(10). P. 941-950.
40. Dinis D., Barbosa-Póvoa A. and Teixeira Â.P. A supporting framework for maintenance capacity planning and scheduling: Development and application in the aircraft MRO industry. *International Journal of Production Economics*. 2019(218). P. 1-15.

41. Qin Y., Zhang J.H., Chan F.T., Chung S.H., Niu B. and Qu T. A two-stage optimization approach for aircraft hangar maintenance planning and staff assignment problems under MRO outsourcing mode. *Computers & Industrial Engineering*. 2020(146). P. 106607.
42. Peschiera F., Battaïa O., Haït A. and Dupin N. Long term planning of military aircraft flight and maintenance operations. *ISAE-SUPAERO, Universite de Toulouse, France*. 2020
43. Yang Z. and Yang, G. Optimization of aircraft maintenance plan based on genetic algorithm. *Physics Procedia*. 2012(33). P. 580-586.
44. Deng Q., Santos B.F. and Verhagen W.J. 2021. A novel decision support system for optimizing aircraft maintenance check schedule and task allocation. *Decision Support Systems*. 2021(146). P. 113545.
45. Papakostas N., Papachatzakis P., Xanthakis V., Mourtzis D. and Chryssolouris G. An approach to operational aircraft maintenance planning. *Decision support systems*. 2010, Vol. 48(4). P. 604-612.
46. Goossens H., Van Blokland W.B. and Curran R. The Development and Application and of a Value-Driven Aircraft Maintenance Operations Performance Assessment Model Combined with Real Options Analysis. *11th AIAA Aviation Technology, Integration, and Operations (ATIO) Conference, including the AIAA Balloon Systems Conference and 19th AIAA Lighter-Than*. 2011. P. 6992
47. Li Z., Guo J. and Zhou R. 2016, January. Maintenance scheduling optimization based on reliability and prognostics information. *In IEEE 2016 Annual Reliability and Maintainability Symposium (RAMS)*. P. 1-5
48. Deng Q., Santos B.F. and Curran R. A practical dynamic programming based methodology for aircraft maintenance check scheduling optimization. *European Journal of Operational Research*. 2020 Vol. 281(2). P. 256-273.
49. Sriram C. and Haghani A. An optimization model for aircraft maintenance scheduling and re-assignment. *Transportation Research Part A: Policy and Practice*. 2003, Vol. 37(1). P. 29-48.

50. Hölzel N.B., Schröder C., Schilling T. and Gollnick V. A maintenance packaging and scheduling optimization method for future aircraft. *In Air Transport and Operations*, IOS Press. P. 343-353
51. De Bruecker P., Van den Bergh J., Beliën J. and Demeulemeester E. A model enhancement heuristic for building robust aircraft maintenance personnel rosters with stochastic constraints. *European Journal of Operational Research*. 2015, Vol. 246(2). P. 661-673.
52. Lee Y., Park J. and Lee D. Inspection interval optimization of aircraft landing gear component based on risk assessment using equivalent initial flaw size distribution method. *Structural Health Monitoring*. 2022, Vol.21(4). P. 1396-1406.
53. Yang J.N. and Trapp W.J. Inspection frequency optimization for aircraft structures based on reliability analysis. *Journal of aircraft*. 1975, Vol.12(5). P. 494-496.
54. Jiang L.P. 2012. An optimization model for aircraft maintenance scheduling based on ABC algorithm. *Advanced Materials Research*, Trans Tech Publications Ltd. 2012, Vol. 490. P. 147-151.
55. Lin L., Wang F. and Luo B. An optimization algorithm inspired by propagation of yeast for fleet maintenance decision making problem involving fatigue structures. *Applied Soft Computing*. 2019, Vol. 85. P. 105755.
56. Sanchez D.T., Boyacı B. and Zografos K.G. An optimisation framework for airline fleet maintenance scheduling with tail assignment considerations. *Transportation Research Part B: Methodological*. 2020. Vol. 133. P. 142-164.
57. Li H., Zuo H., Lei D., Liang K. and Lu T. Optimal combination of aircraft maintenance tasks by a novel simplex optimization method. *Mathematical Problems in Engineering*. 2015.
58. Witteman M., Deng Q. and Santos B.F. A bin packing approach to solve the aircraft maintenance task allocation problem. *European Journal of Operational Research*. 2021, Vol 294. P. 365-376.

59. Li H., Zuo H., Liang K., Xu J., Cai J. and Liu J. Optimizing combination of aircraft maintenance tasks by adaptive genetic algorithm based on cluster search. *Journal of Systems Engineering and Electronics*. 2016, Vol. 27(1). P. 140-156.
60. Muchiri A.K. and Smit K. Optimizing aircraft line maintenance through task re-clustering and interval de-escalation. *Faculty of Aerospace Engineering, Delft University of Technology*. 2017.
61. Ali B., Kamal K., Usman M., Mah-e-Zehra. Optimization of aircraft maintenance routing using uninformed and informed search algorithms. *International Journal of Mechanical Engineering and Robotics Research*. 2019. P. 141-145
62. Safaei N. and Jardine A.K. Aircraft routing with generalized maintenance constraints. *Omega (United Kingdom)*. 2018, Vol. 80. P. 111-122.
63. Gopalan R. and Talluri K.T. The aircraft maintenance routing problem. *Operations research*. 1998, 46(2). P. 260-271.
64. Ahmed M.B., Mansour F.Z. and Haouari M. A two-level optimization approach for robust aircraft routing and retiming. *Computers & Industrial Engineering*. 2017, Vol. 112. P. 586-594.
65. Cui R., Dong X. and Lin Y. Models for aircraft maintenance routing problem with consideration of remaining time and robustness. *Computers & Industrial Engineering*. 2019, Vol. 137. P. 106045.
66. Eltoukhy A.E., Chan F.T., Chung S.H. and Niu B. 2018. A model with a solution algorithm for the operational aircraft maintenance routing problem. *Computers & Industrial Engineering*. 2018, Vol. 120. P. 346-359.
67. Al-Thani N.A., Ahmed M.B. and Haouari M. A model and optimization-based heuristic for the operational aircraft maintenance routing problem. *Transportation Research Part C: Emerging Technologies*. 2016, Vol. 72. P. 29-44.
68. Sarac A., Batta R. and Rump C.M. A branch-and-price approach for operational aircraft maintenance routing. *European Journal of Operational Research*. 2006, Vol. 175(3). P. 1850-1869.

69. Başdere M. and Bilge Ü. Operational aircraft maintenance routing problem with remaining time consideration. *European Journal of Operational Research*. 2014, Vol. 235(1). P. 315-328.
70. Eltoukhy A.E.E., Wang Z.X., Chan F.T.S., Chung S.H. Joint optimization using a leader-follower Stackelberg game for coordinated configuration of stochastic operational aircraft maintenance routing and maintenance staffing. *Computers & Industrial Engineering*. 2018. doi.org/10.1016/j.cie. 2018.08.012
71. Feng Y.W., Chen J.Y., Lu C. and Zhu S.P. Civil aircraft spare parts prediction and configuration management techniques: review and prospect. *Advances in Mechanical Engineering*. 2021, Vol.13(6).
72. Gu J., Zhang G. and Li K.W. Efficient aircraft spare parts inventory management under demand uncertainty. *Journal of air transport management*. 2015, Vol. 42. P. 101-109.
73. Fritzsche R. and Lasch R. An integrated logistics model of spare parts maintenance planning within the aviation industry. *Proceedings of world academy of science, engineering and technology*. 2012, Vol. 68.
74. Ni X., Zuo H. and Liu, M. Research on optimization model of civil aircraft spare parts inventory allocation. *IEEE Chinese control and decision conference*. 2008. P. 1042-1045.
75. Cai J., Li X. and Chen X. Joint optimization of maintenance inspection and spare provisioning for aircraft deteriorating parts. *Journal of Systems Engineering and Electronics*. 2017, Vol. 28(6). P. 1133-1140.
76. Li Y., Feng Y., Xue X. and Lu C. A united allocation method of spare parts and ground maintenance equipment for civil aircraft. *MATEC Web of Conferences EDP Sciences*. 2017, Vol. 114. P. 03006.
77. Lee L.H., Chew E.P., Teng S. and Chen Y. Multi-objective simulation-based evolutionary algorithm for an aircraft spare parts allocation problem. *European Journal of Operational Research*. 2008, Vol. 189(2). P. 476-491.
78. De Bruecker P., Beliën J., Van den Bergh J. and Demeulemeester E. A three-stage mixed integer programming approach for optimizing the skill mix and training schedules for

- aircraft maintenance. *European Journal of Operational Research*. 2018, Vol. 267(2). P. 439-452.
79. De Bruecker P., Van den Bergh J., Belien J. and Demeulemeester E. A two-stage mixed integer programming approach for optimizing the skill mix and training schedules for aircraft maintenance. 2015. Available at SSRN 2697491.
80. Stadnicka D., Arkhipov D., Battaïa O. and Ratnayake R.C. Skills management in the optimization of aircraft maintenance processes. *IFAC-PapersOnLine*. 2017, Vol. 50(1). P. 6912-6917.
81. Feng Q., Li S. and Sun B. 2014. A multi-agent based intelligent configuration method for aircraft fleet maintenance personnel. *Chinese Journal of Aeronautics*. 2014, Vol. 27(2). P. 280-290.
82. Rodrigues L.R., Gomes J.P., Ferri F.A., Medeiros I.P., Galvao R.K. and Júnior C.L.N. Use of PHM information and system architecture for optimized aircraft maintenance planning. *IEEE Systems Journal*. 2014, Vol. 9(4). P. 1197-1207.
83. Ferri F.A.S., Rodrigues L.R., Gomes J.P.P., de Medeiros I.P., Galvão R.K.H. and Nascimento C.L. Combining PHM information and system architecture to support aircraft maintenance planning. *IEEE International Systems Conference (SysCon)*. 2013. P. 60-65.
84. Vianna W.O.L. and Yoneyama T. Predictive maintenance optimization for aircraft redundant systems subjected to multiple wear profiles. *IEEE Systems Journal*. 2017, Vol. 12(2). P. 1170-1181.
85. Susova G.M. and Petrov A.N. Markov model-based reliability and safety evaluation for aircraft maintenance-system optimization. *IEEE Annual Reliability and Maintainability Symposium*. 1997. P. 29-36.
86. Guo J., Li Z. and Wolf J. 2016, January. Reliability centered preventive maintenance optimization for aircraft indicators. *IEEE Annual Reliability and Maintainability Symposium (RAMS)*. 2016. P. 1-6.

87. Shanmuganathan V.K., Haran A.P., Ragavendran S. and Gayathri N. Aero-Engine Maintenance cost optimization by RCM. *Life Science Journal*. 2013, Vol.10(1). P. 2891-2896.
88. Dekker R. and Scarf P.A. On the impact of optimisation models in maintenance decision making: the state of the art. *Reliability Engineering & System Safety*. 1998, Vol.60(2). P. 111-119.
89. International Air Transport Association (IATA). Best Practices for Component Maintenance Cost Management. 2015.
90. Jiang Y., Zhang H., Song X., Jiao X., Hung W.N., Gu M. and Sun J. Bayesian-network-based reliability analysis of PLC systems. *IEEE transactions on industrial electronics*. 2012, Vol. 60(11). P. 5325-5336.
91. Pandian G.P., Diganta D.A.S., Chuan L.I., Enrico Z.I.O. and Pecht M. A critique of reliability prediction techniques for avionics applications. *Chinese Journal of Aeronautics*. 2018, Vol. 31(1). P. 10-20.
92. Uganda Civil Aviation Authority (CAA Uganda). Maintenance Control by Reliability Methods, Advisory Circular CAA-AC-AWS010. 2013.
93. Hu C. and Youn B.D. Adaptive-sparse polynomial chaos expansion for reliability analysis and design of complex engineering systems. *Structural and Multidisciplinary Optimization*. 2011, Vol. 43(3). P. 419-442.
94. General information from the theory of reliability, Reliability of Aircraft lecture notes, Burlakov V.I, National Aviation University, Kyiv, Ukraine, In Russian
95. Nakagawa T. Maintenance theory of reliability. *Springer Science & Business Media*. 2005.
96. Huang J., Song Y., Ren Y. and Gao Q. An optimization method of aircraft periodic inspection and maintenance based on the zero-failure data analysis. *IEEE Chinese Guidance, Navigation and Control Conference*. 2014. P. 319-323.
97. Zaliskyi M., Petrova Y., Asanov M. and Bekirov E. Statistical data processing during wind generators operation. *International Journal of Electrical and Electronic Engineering & Telecommunications*. 2019, Vol. 88(1). P. 33-38. doi.org/10.18178/ijeetc.8.1.33-38.

98. Zaliskyi M., Solomentsev O., Kozhokhina O. and Herasymenko T. Reliability parameters estimation for radioelectronic equipment in case of change-point. *IEEE Signal Processing Symposium (SPSymposium)*, Jachranka Village, Poland. 2017. P. 1-4. doi.org/10.1109/SPS.2017.8053676.
99. Solomentsev O., Zaliskyi M., Herasymenko T. and Petrova Y. Data processing method for deterioration detection during radio equipment operation. *IEEE Microwave Theory and Techniques in Wireless Communications (MTTW)*. 2019, Vol. 1. P. 1-4.
100. Solomentsev O., Zaliskyi M., Nemyrovets Y. and Asanov M. Signal processing in case of radio equipment technical state deterioration. *IEEE Signal Processing Symposium (SPSymposium)*, Debe, Poland. 2015. P. 1-5. doi.org/10.1109/SPS.2015.7168312.
101. Hryshchenko Y. Reliability Problem of Ergatic Control Systems in Aviation. *IEEE 4th International Conference on Methods and Systems of Navigation and Motion Control (MSNMC)*, Kyiv, Ukraine. 2016. P.126-129. doi.org/10.1109/MSNMC.2016.7783123.
102. Melkumyan V. Technological Systems of Service Type. Elements of Design Theory and Applied Problems of Operation, National Aviation University, Kyiv. 2003, P. 171. (in Ukrainian)
103. Solomentsev O.V., Melkumyan V.H., Zaliskyi M.Y. and Asanov M.M. UAV operation system designing. *IEEE International Conference Actual Problems of Unmanned Aerial Vehicles Developments (APUAVD)*, Kyiv, Ukraine. 2015. P. 95-98. doi.org/10.1109/APUAVD.2015.7346570.
104. Taranenko A.G., Gabrousenko Ye.I., Holubnychiy A.G. and Slipukhina, I.A. Estimation of Redundant Radionavigation System Reliability. Proceedings of IEEE 5th International Conference on Methods and Systems of Navigation and Motion Control, Kyiv, Ukraine. 2018. P. 28-31. doi.org/10.1109/MSNMC.2018.8576282.
105. Barlow R. E. and Proschan F. Mathematical Theory of Reliability. John Wiley and Sons, New York. 1965. 274 p.
106. Rubinstein R.Y. and Kroese D.P. Simulation and the Monte Carlo Method, Second Edition. John Wiley & Sons. 2008.

107. Churchman C.W., Ackoff R.L. and Arnoff E.L. Introduction to Operations Research, Wiley, New York. 1959.
108. Kiviat P. J. Digital Computer Simulation: Modelling Concepts, Report RM-5378-PR. *The Rand Corporation*, Santa Monica, California. 1967.
109. Papadopoulos V., Giovanis D.G., Lagaros N.D. and Papadrakakis M. Accelerated subset simulation with neural networks for reliability analysis. *Computer Methods in Applied Mechanics and Engineering*. 2012. P. 70-80.
110. Dubourg V. Adaptive surrogate models for reliability analysis and reliability-based design optimization. Doctoral dissertation, Université Blaise Pascal-Clermont-Ferrand II. 2011.
111. Dubourg V., Sudret B. and Deheeger F. Metamodel-based importance sampling for structural reliability analysis. *Probabilistic Engineering Mechanics*. 2013, Vol. 33. P. 47-57.
112. Keshtegar B. and Meng Z. A hybrid relaxed first-order reliability method for efficient structural reliability analysis. *Structural Safety*. 2017, Vol. 66. P. 84-93.
113. Sinha R.K., Shah S.A., Hume, E.L. and Tuan R.S. The effect of a 5-day space flight on the immature rat spine. *The Spine Journal*. 2002, Vol. 2(4). P. 239-243. doi.org/10.1016/S1529-9430(02)00197-3.
114. Yang J.H., Kennedy Q., Sullivan J. and Fricker R.D. Pilot performance: assessing how scan patterns & navigational assessments vary by flight expertise. *Aviation, space, and environmental medicine*. 2013, Vol. 84(2). P. 116-124. doi.org/10.3357/ASEM.3372.2013.
115. Knecht W.R. The “killing zone” revisited: Serial nonlinearities predict general aviation accident rates from pilot total flight hours. *Accident Analysis & Prevention*. 2013, Vol. 60. P. 50-56. doi.org/10.1016/j.aap.2013.08.012.
116. English J.M. and Kernan G.L. The prediction of air travel and aircraft technology to the year 2000 using the Delphi method. *Transportation research*. 1976, Vol.10(1). P. 1-8. doi.org/10.1016/0041-1647(76)90094-0.

117. Varoquaux G. Cross-validation failure: Small sample sizes lead to large error bars. *Neuroimage*. 2018, Vol.180. P. 68-77. doi.org/10.1016/j.neuroimage.2017.06.061.
118. Matuschek H., Kliegl R., Vasishth S., Baayen H. and Bates D. Balancing Type I error and power in linear mixed models. *Journal of memory and language*. 2017, Vol.94. P. 305-315. doi.org/10.1016/j.jml.2017.01.001.
119. D'souza R.N., Huang P.Y. and Yeh F.C. 2020. Structural analysis and optimization of convolutional neural networks with a small sample size. *Scientific reports*. 2020, Vol. 10(1). P. 1-13.
120. Dwivedi A.K., Mallawaarachchi I. and Alvarado L.A. Analysis of small sample size studies using nonparametric bootstrap test with pooled resampling method. *Statistics in medicine*. 2017, Vol. 36(14). P. 2187-2205. doi.org/10.1002/sim.7263.
121. Liu S. and Deng W. Very deep convolutional neural network based image classification using small training sample size. 3rd IAPR Asian conference on pattern recognition (ACPR), IEEE. 2015. P. 730-734. doi.org/10.1109/ACPR.2015.7486599.
122. Han L., Yang G., Dai H., Xu B., Yang H., Feng H., Li Z. and Yang X. Modeling maize above-ground biomass based on machine learning approaches using UAV remote-sensing data. *Plant methods*. 2019, Vol. 15(1). P. 1-19.
123. Gou J., Ma H., Ou W., Zeng S., Rao Y., Yang H. A generalized mean distance-based k-nearest neighbor classifier. *Expert Systems with Applications*. 2019, Vol. 115. P. 356-372. doi.org/10.1016/j.eswa.2018.08.021.
124. Zaidan M.A., Harrison R.F., Mills A.R. and Fleming P.J. Bayesian hierarchical models for aerospace gas turbine engine prognostics. *Expert Systems with Applications*. 2015, Vol. 42(1). P. 539-553. doi.org/10.1016/j.eswa.2014.08.007
125. Wang C., Guo J. and Shen A. Sensitivity analysis of censoring data from component failure analysis and reliability evaluation for the aviation internet of things. *Computer Communications*. 2020, Vol. 157. P. 28-37. doi.org/10.1016/j.comcom.2020.04.003

126. Chen X., Huang J. and Yi M. Cost estimation for general aviation aircrafts using regression models and variable importance in projection analysis. *Journal of cleaner production*. 2020, Vol. 256. P. 120648. doi.org/10.1016/j.jclepro.2020.120648.
127. Combrisson E. and Jerbi K. Exceeding chance level by chance: The caveat of theoretical chance levels in brain signal classification and statistical assessment of decoding accuracy. *Journal of neuroscience methods*. 2015, Vol.250. P. 126-136. doi.org/10.1016/j.jneumeth.2015.01.010.
128. ADS-79D-HDBK, Aeronautical Design Standard: Handbook for Condition-based Maintenance System for US Army Aircraft (Put onto operation 07.03.2013), Huntsville, USA. 2013. 284 p
129. Solomentsev O., Zaliskyi M., Shcherbyna O. and Kozhokhina O. Sequential procedure of changepoint analysis during operational data processing. *IEEE Microwave Theory and Techniques in Wireless Communications (MTTW)*. 2020, Vol. 1. P. 168-171. doi.org/10.1109/MTTW51045.2020.9245068.
130. Goncharenko A. V. Optimal UAV Maintenance Periodicity Obtained on the Multi-optional Basis. *Proceedings of IEEE 4th International Conference on Actual Problems of UAV Developments*. 2017. P. 65-68. doi.org/10.1109/APUAVD.2017.8308778.
131. Ulansky V. and Terentyeva I. Availability assessment of a telecommunications system with permanent and intermittent faults. *IEEE First Ukraine Conference on Electrical and Computer Engineering 2017*. P. 908-911. doi.org/10.1109/UKRCON.2017.8100386.
132. Ulansky V. and Raza A. Determination of the optimal maintenance threshold and periodicity of condition monitoring. *1st World Congress on Condition Monitoring, London*. 2017. P. 1343-1355. doi.org/10.3390/e21121193.
133. Gkioulekas I. and Papageorgiou L.G. Piecewise regression analysis through information criteria using mathematical programming. *Expert Systems with Applications*. 2019, Vol.121. P. 362-372.
134. Evans M.J. and Rosenthal J.S. *Probability and Statistics, The Science of Uncertainty* Second Edition. University of Toronto. 2009.

135. Chatterjee S., and Hadi A.S. Regression Analysis by Example, 5th Edition. Wiley Series in Probability and Statistics. 2013.
136. Seber G.A. and Lee A.J. Nonlinear Regression. Wiley series in probability and statistics. 2003. P.36-44.
137. Toms J.D. and Lesperance M.L. Piecewise regression: a tool for identifying ecological thresholds. Ecology. 2003, Vol. 84(8). P. 2034-2041.
138. Gopalakrishnan P. and Banerji A.K. Maintenance and spare parts management. PHI Private Limited Delhi. 2013. 400p.
139. Slater P. Smart inventory solutions: improving the management of engineering materials and spare parts. Industrial Press Inc. 2010. 275p.
140. Kontrec N.Z., Milovanović G.V., Panić S.R. and Milošević H. A reliability-based approach to nonrepairable spare part forecasting in aircraft maintenance system. Mathematical Problems in Engineering. 2015. doi.org/10.1155/2015/731437.
141. SKYBrary. Minimum Equipment List (MEL). URL: <https://skybrary.aero/articles/minimum-equipment-list-mel>.
142. Manzini R., Regattieri A., Pham H. and Ferrari E. Maintenance for industrial systems. Springer Series in Reliability Engineering. 2010. 479p.
143. S.R. Singh. Spare Parts. URL:<https://www.scribd.com/document/106343769/Spare-Parts>
144. Boeing 737-300/400/500 maintenance planning data. Section 8, Component Maintenance Information.
145. Thomas D.S. and Weiss B. Maintenance Costs and Advanced Maintenance Techniques: Survey and Analysis. International Journal of Prognostics and Health Management. 2021, Vol.12(1). doi.org/10.36001/ijphm.2021.v12i1.2883
146. Krokotsch T., Knaak M. and Gühmann C. Improving Semi-Supervised Learning for Remaining Useful Lifetime Estimation Through Self-Supervision. International Journal of Prognostics and Health Management. 2022, Vol. 13.

147. Oikonomou A., Eleftheroglou N., Freeman F., Loutas T., and Zarouchas D. Remaining Useful Life Prognosis of Aircraft Brakes. *International Journal of Prognostics and Health Management*. 2022. doi.org/10.36001/ijphm.2022.v13i1.3072.
148. Mauthe F., Hagemeyer S. and Zeiler P. Creation of Publicly Available Data Sets for Prognostics and Diagnostics Addressing Data Scenarios Relevant to Industrial Applications. *International Journal of Prognostics and Health Management*. 2021, Vol.12(2). doi.org/10.36001/ijphm.2021.v12i2.3087
149. Okoro O.C. Reliability Analysis of Aircraft Fleet in Nigeria. *Proceedings of National Aviation University*. 2020, Vol. 83 (2). P.49–53.
150. Rubinstein, R.Y. *Simulation and the Monte Carlo Method*, Second Edition. John Wiley & Sons. 1981.
151. Florescu R. and Thirer N. Distribution Laws of Small Size Samples. *Metrological Implementation. Proceedings of IEEE 24th Convention of Electrical & Electronics Engineers in Israel*. 2006. P. 79-81. doi:10.1109/eeei.2006.321099.
152. Dai Z, Wang Z. and Jiao Y. Bayes Monte-Carlo assessment method of protection systems reliability based on small failure sample data. *IEEE Transactions on Power Delivery*. 2014, Vol. 29(4). P. 1841-1848. doi:10.1109/tpwrdr.2014.2316915.
153. Zhang H., Yuan H. and Li P. Estimation method for extremely small sample accelerated degradation test data. *First IEEE International Conference on Reliability Systems Engineering (ICRSE)*, China. 2015. P. 1-5. doi:10.1109/icrse.2015.7366417.
154. Hou Y. and Yang B. Probability-possibility transformation for small sample size data. *IEEE Seventh International Conference on Fuzzy Systems and Knowledge Discovery*, Yantai, China. 2010, Vol. 4. P. 1720-1724. doi:10.1109/fskd.2010.5569396.
155. Qingnian Y. and Yuzhou S. The fitting method of parameter distributions in geotechnical engineering under small sample. *Proceedings of IEEE 2nd International Conference on Artificial Intelligence, Management Science and Electronic Commerce (AIMSEC)*, Dengleng, China. P. 7366-7369. 2011. doi:10.1109/aimsec.2011.6010605.

156. Kuzmin V.N. and P.I. Bidyuk. A New Approach to Detection and Correction of Outliers. Proceedings of 14th International Scientific Conference named after Academician M. Kravchuk. 2012. P. 13-15.
157. Kuzmin V.M., Zaliskyi M.Y., Odarchenko R.S. and Petrova Y.V. New approach to switching points optimization for segmented regression during mathematical model building. 4th Workshop for Young Scientists in Computer Science & Software Engineering. 2022.
158. Ostroumov I.V. and Kuzmenko N.S. Accuracy improvement of VOR/VOR navigation with angle extrapolation by linear regression. Telecommunications and Radio Engineering. 2019, Vol. 78(15). P. 1399–1412. doi: 10.1615/TelecomRadEng.v78.i15.90.
159. Radonja P., Stankovic S., Matovic B. and Drazic D. Regional Models for Biological Processes Based on Linear Regression and Neural Networks. 8th IEEE Seminar on Neural Network Applications in Electrical Engineering. 2006. P. 189-193. doi: 10.1109/NEUREL.2006.341209.
160. Feng X., Zhou Y., Hua T., Zou Y. and Xiao J. Contact temperature prediction of high voltage switchgear based on multiple linear regression model. In IEEE 32nd Youth Academic Annual Conference of Chinese Association of Automation (YAC), Hefei, China. 2017. P. 277-280. doi: 10.1109/YAC.2017.7967419.
161. Weisberg S. Applied Linear Regression. John Wiley and Sons, New York. 2005. 310 p.
162. Atkinson A.C., Riani M. Robust diagnostic regression analysis. Springer Series in Statistics. 2000, Vol. 2. 328 p. doi: 10.1007/978-1-4612-1160-0.
163. D. G. Kleinbaum, M. Klein. Logistic Regression. Springer-Verlag, New York. 2002. 598 p. doi: 10.1007/b97379.
164. Huet S., Bouvier A., Poursat M.A., Jolivet E. and Bouvier A.M. 2004. Statistical tools for nonlinear regression: a practical guide with S-PLUS and R examples. Springer, New York. 233 p.
165. Kaufman R.L. Heteroskedasticity in regression: Detection and correction. SAGE Publications. 2013. 112 p.

166. Zaliskyi M., Solomentsev O., Shcherbyna O., Ostroumov I., Sushchenko O., Averyanova Y., Kuzmenko N., Shmatko O., Ruzhentsev N., Popov A. and Zhyla S. 2021. Heteroskedasticity analysis during operational data processing of radio electronic systems. *Data Science and Security, Lecture Notes in Networks and Systems*. Springer, Singapore. 2021. P. 168-175. [10.1007/978-981-16-4486-3_18](https://doi.org/10.1007/978-981-16-4486-3_18).
167. Ostroumov I., Kuzmenko N., Sushchenko O., Zaliskyi M., Solomentsev O., Averyanova Y., Zhyla S., Pavlikov V., Tserne E., Volosyuk V. and Dergachov K. A probability estimation of aircraft departures and arrivals delays. In *International Conference on Computational Science and Its Applications. Lecture Notes in Computer Science*, Springer, Cham. 2021. P. 363-377 Springer, Cham. doi.org/10.1007/978-3-030-86960-1_26.
168. Ostroumov I., Kuzmenko N., Sushchenko O., Pavlikov V., Zhyla S., Solomentsev O., Zaliskyi M., Averyanova Y., Tserne E., Popov A. and Volosyuk V. Modelling and simulation of DME navigation global service volume. *Advances in Space Research*. 2021, Vol. 68(8). P. 3495-3507. doi.org/10.1016/j.asr.2021.06.027.
169. Okoro O.C., Zaliskyi M., Dmytriiev S., Solomentsev O. and Sribna O. Optimization of Maintenance Task Interval of Aircraft Systems. *International Journal of Computer Network & Information Security*. 2022, Vol. 14(2).
170. Wang W. A joint spare part and maintenance inspection optimisation model using the delay-time concept. *Reliability Engineering & System Safety*. 2011, Vol. 96(11). P. 1535-1541.
171. Figueiredo-Pinto D.G., Fan I.S. and Abrahão F.T.M. An Operational Availability Optimization Model Based on the Integration of Predictive and Scheduled Maintenance. In *PHM Society European Conference*. 2021, Vol. 6(1).
172. Bozoudis M., Lappas I. and Kottas A. Use of cost-adjusted importance measures for aircraft system maintenance optimization. *Aerospace*. 2018, Vol.5(3). P. 68.
173. Zhang J.X., Du D.B., Si X.S., Hu C.H. and Zhang H.W. Joint optimization of preventive maintenance and inventory management for standby systems with hybrid-deteriorating spare parts. *Reliability Engineering & System Safety*. 2014, Vol. 214. P. 107686.

174. Fauriat W. and Zio E. Optimization of an aperiodic sequential inspection and condition-based maintenance policy driven by value of information. *Reliability Engineering & System Safety*. 2020, Vol. 204. P. 107133.

APPENDIX 1

Algorithm of software implementation for developing mathematical models for aircraft maintenance processes for continuing airworthiness in Nigeria.

ALGORITHM OF SOFTWARE IMPLEMENTATION FOR DEVELOPING MATHEMATICAL MODELS FOR OPTIMIZING AIRCRAFT MAINTENANCE PROCESSES FOR CONTINUING AIRWORTHINESS.

Mathcad-script

Mathcad-скрипт

A := []

V := histogram (n, t)

j := 0..(n-1)

plot (V_{j,1}, V_{j,0})

plot (i, B_i)

N := iterations

k := 0..N-1

C := rexp (N, λ)

$D_k := \sum_{j=0}^k C_j$

E_k := md(1)

F_{i,k} := 0

F_{n-1,k} := |D_k if E_k ≤ B₀ otherwise 0|

i := 1..m

$F_{n,k} := |D_k \text{ if } B_{i-1} < E_k \leq B_i \text{ otherwise } 0|$

$i := 0..m$

$A_n := |s \text{ evaluate } 0 \text{ for } k, \text{ for } k \in 0..N-1, \text{ if } F_{n-1,k} \neq 0| \text{ a}_s \text{ evaluate } F_{n-1,k}, \text{ s evaluate } s+1| \text{ a}|$

$p := 1..length(A_n) - 1$

$B_{n_0} := A_{n_0}$

$B_{n_p} := A_{n_p} - A_{n_{p-1}}$

$ceil(\sqrt{length(A_n)}) - 1$

$V := \text{histogram}(ceil(\sqrt{length(A_n)}) - 1, B_n$

$j := 0..(ceil(\sqrt{length(A_n)}) - 1$

$\text{plot}(V_{j,1}, V_{j,0})$

$x = [x_0, x_1, x_2, x_3, x_4, \dots, x_n]$

$x := \text{sort}(x)$

$\text{mean}(x) = []$

$\text{stdev}(x) = []$

$\text{median}(x) = []$

$\frac{\text{stdev}(x)}{\text{mean}(x)} = [cv]$

$A := \text{histogram}(6, x)$

$i := 0..n-1$

$j := 0..m$

$\text{plot}(A_{j,1}, A_{j,0})$

$\sqrt[3]{n} \cdot 1.5 = t$

$k := 0..t$

$$ymin_k := \frac{x_k}{median(x)}$$

$$ymax_k := \frac{x_k + 46}{median(x)}$$

$$ymin := \ln(ymin)$$

$$ymax := \ln(ymax)$$

$$up_1 := \frac{stdev(x)}{mean(x)} \cdot \sum_{k=1}^t up_k$$

$$up_2 := \left| \sum_{k=1}^t up_k \right| \cdot \frac{stdev(x)}{mean(x)}$$

$$\frac{y_1}{up_1} = []$$

$$\frac{y_2}{up_2} = []$$

$$a_1 := e^{\frac{y_1}{up_1}}$$

$$a_2 := e^{\frac{y_2}{up_2}}$$

$$x_n := median(x) \cdot a_1^{|up \cdot cv|}$$

$$BF_i = \frac{a_1 \cdot e^{-up_i} + a_2 \cdot e^{up_i}}{e^{-up_i} + e^{up_i}}$$

$$BF2_i = BF_i(up_i)$$

$$Q_i = median(x) \cdot (BF_i)^{up_i \cdot cv}$$

$$Q2_i = median(x) \cdot (BF2_i)^{up_i \cdot cv}$$

$$Q1_i = mean(x) \cdot up_i \cdot stdev(x)$$

$$plot(x_i, Q_i, Q2_i, Q1_i, up_i)$$

$C := []$

$X := 1..n$

plot (C_i , $Y(X)$, i , X)

$C_r := []$

$C_m := []$

$\lambda := []$

$T_m := 1000, 1500..50000$

$$E_f(T_m) := \frac{C_r E_n(T_m) + C_m}{T_m}$$

$$E_{f_i}(T_m) := \frac{C_r \left(\frac{\lambda \cdot T_m}{2} + \frac{e^{-2\lambda \cdot T_m}}{4} - \frac{1}{4} \right)}{T_m} + C_m$$

plot ($E_f(T_m)$, $E_{f_i}(T_m)$ T_m)

$\lambda := []$

$A := 1..n$

$P := 0.90..0.95$

$N := 1..X$

$M := t$

$$P_{k,i} := \sum_{x=0}^k \frac{(\lambda_i \cdot t)^x e^{-\lambda_i \cdot t}}{x!}$$

plot ($P_z(t, \lambda_0, z)$, $P_z(t, \lambda_1, z)$, $P_z(t, \lambda_2, z)$, ..., $P_z(t, \lambda_n, z)$, z)

APPENDIX 2

List of publications, information on the approval and implementation of the results of the
dissertation

LIST OF PUBLICATIONS BASED ON DISSERTATION TOPIC

Publications included in the international scientometric database (Scopus)

Publications included in the international scientometric database (Scopus)

18. Okoro O.C., Zaliskyi M., Dmytriiev S., Solomentsev O., Sribna O. Optimization of Maintenance Task Interval of Aircraft Systems. *International Journal of Computer Network & Information Security*. 2022. Volume 14. No 2. P. 77–89.
Author's contribution: development of stochastic mathematical models using diagnostic variables and reliability parameters to determine optimal aircraft maintenance task interval.
19. Okoro O.C., Zaliskyi M., Serhii D., Abule I. An approach to reliability analysis of aircraft systems for a small dataset. *Scientific Journal of Silesian University of Technology. Series Transport*. 2023. Volume 118. P. 207–217.
Author's contribution: development of a model for the reliability analysis of aircraft components, subsystems, systems, and structures given a small dataset which is typical of small-scale aircraft operations.
20. Zaliskyi M., Okoro O.C., Dmytriiev S., Fayoyiwa O.S.. Software Support for Simulation and Prediction of Failures and Faults During Aircraft Operations. *Lecture Notes in Networks and Systems*. 2023. Volume 736. P. 247–259.
Author's contribution: development of software framework for predicting failures and malfunctions of aircraft components, subsystems, systems, and structures.

21. Zaliskyi M., Yashanov I., Okoro O.C., Shcherbyna O. Analysis of Learning Efficiency of Expert System for Decision-Making Support in Aviation. *Advanced Computer Information Technologies (ACIT): Proceedings of IEEE 12th International Conference, Ruzomberok (Slovakia). 26-28 September 2022. P. 172–175.*

Author's contribution: efficiency analysis of different expert system for decision-making support in aircraft operations.

22. Okoro O.C., Chukwu C.N., Zaliskyi M., Holubnychyi O. A Method for Planning Spare Parts Inventory During Aircraft Operation *Advanced Computer Information Technologies (ACIT): Proceedings of IEEE 12th International Conference, Ruzomberok (Slovakia). 26-28 September 2022. P. 168–171.*

Author's contribution: development of methodology for aircraft spare parts planning using statistical data of times to failure of aircraft components.

23. Okoro O.C., Zaliskyi M., Dmytriiev S., Qudus S. Data-Driven Approach to Optimal Aircraft Maintenance. *The International Council of the Aeronautical Sciences: Proceedings of 33rd Congress, Stockholm (Sweden). 4 – 9 September 2022. P. 7114–7124.*

Author's contribution: development and synthesis of statistical data processing algorithms and models to improve the efficiency of aircraft maintenance.

Publications in scientific and specialized Ukrainian Journals

24. Okoro O.C. Reliability Analysis of Aircraft Fleet in Nigeria. *Proceedings of National Aviation University. 2020, Volume 83 (2). P.49–53.*

Author's contribution: analysis of reliability indicators of aircraft and helicopters in Nigeria.

25. Око́ро О. Ч., Дми́трієв С. О., За́ліський М. Ю., Осі́пчук А. О. Моделі для аналізу надійності авіаційних компонентів, систем та конструкцій повітряних суден. Системи управління, навігації та зв'язку. Збірник наукових праць. 2022. Том 4 (№ 70). С. 16–21.

Author's contribution: development of a statistically simulated reliability model that can be applied during the design and development of components, systems, and structures of helicopters.

26. Огоро О. Ч., Дмитрієв С. О., Заліський М. Ю., Осіпчук А. О. Статистичні імітаційні моделі оптимізації технічного обслуговування повітряних суден. Системи управління, навігації та зв'язку. Збірник наукових праць. 2022. Том 3 (№ 69). С. 8–12.

Author's contribution: development of a statistical simulation model of failures of aircraft systems and structures using the Monte Carlo method.

Publications in collections of conference materials

27. Okoro O.C. Optimization of Aircraft Maintenance Processes Using Regression Analysis. Current Security Problems in Transport, Energy, and Infrastructure: Proceedings of Conference, Kherson. 2021. P. 244.

Author's contribution: development of a linear regression model for failure prediction of aircraft systems and components using aircraft operations data from Nigeria.

28. Okoro O.C., Zaliskyi M., Dmytriiev S. Statistical simulation regression models for efficient aircraft operations. Aviation in the XXI-st century - Safety in aviation and space technology: Proceedings of The Tenth World Congress, Kyiv. 28 – 30 September 2022. P. 1–5.

Author's contribution: development of segmented regression models for precise prediction of the occurrence of failures of aircraft components, systems and structures using daily operation aircraft data.

29. Zaliskyi M., Okoro O.C., Dmytriiev S. Statistical Simulation of Failures of the Systems and Structures of S-76 C++ Helicopters in Nigeria. Cyber Hygiene & Conflict Management in Global Information Networks: Proceedings of 2nd International Conference, Kyiv-Lviv. 30 November 2020. P. 1–10.

Author's contribution: development of a statistical model for failure simulation of aircraft components.

30. Okoro O.C., Zaliskyi M., Dmytriiev S. Statistical Simulation Models for the Optimization of Aircraft Maintenance Processes. Problems of Transportation Organization and Air Transport Management: Proceedings of International Scientific-Practical Conference, Kyiv, NAU, 20 October 2021. P-3.
Author's contribution: development of methodology for determining the optimal time interval for the maintenance of aircraft.
31. Okoro O.C., Zaliskyi M., Dmytriiev S. Models for Optimizing Aircraft Maintenance Processes. Condition-based Maintenance in Aerospace: Proceedings of 1st International Conference, Delft (Netherlands). 24 – 25 May 2022. P. 1–10.
Author's contribution: Numerical examples for estimating optimal time interval for preventive and predictive aircraft maintenance using exponential probability density function.
32. Okoro O.C., Zaliskyi M. Models and Algorithms for Optimizing Aircraft Maintenance Processes. Air Transport Research Society: Proceedings of 25th World Conference, Antwerp (Belgium). 24 – 27 August 2022. P. 1 – 5.
Author's contribution: Numerical examples for estimating optimal time interval for preventive and predictive aircraft maintenance using Erlang probability density function.
33. Okoro O.C., Zaliskyi M. Optimizing Aircraft Maintenance Processes – An Operations Data-Driven Methodology. Ontario Aircraft Maintenance Conference; The Future of Aircraft Maintenance – Performance, Professionalism and Pride: Proceedings of Conference, Toronto, (Canada). 2-3 November 2022. P.1-18.
Author's contribution: development of simple and concise methodology for practical application of data-driven predictive aircraft maintenance.
34. Okoro O.C., Zaliskyi M., Dmytriiev S. An Approach to Optimizing Aircraft Maintenance. In: Karakoc, T.H., Atipan, S., Dalkiran, A., Ercan, A.H., Kongsamutr, N., Sripawadkul, V. (eds). Research Developments in Sustainable Aviation. ISSA SARES

2021 (Proceedings of International Symposium on Sustainable Aviation, Bangkok, Thailand). Sustainable Aviation. 2023, Springer, Cham, pp. 263–269.

Author's contribution: development of optimized maintenance task intervals of aircraft systems using the average operational cost per unit time as a measure of efficiency.

Approbation of the dissertation results. The research results were discussed at 12 international congresses, symposiums and conferences: 1) 2nd International Conference on Cyber Hygiene & Conflict Management in Global Information Networks (Kyiv-Lviv, Ukraine, 2020); 2) 2021 International Symposium on Network Security and Communications (Kyiv, Ukraine); 3) Current Security Problems in Transport, Energy and Infrastructure Conference (Kherson, Ukraine, 2021); 4) 2021 International Scientific-Practical Conference on Problems of Transportation Organization and Air Transport Management (Kyiv, Ukraine); 5) International Symposium on Sustainable Aviation (Bangkok, Thailand, 2021); 6) 1st International Conference for Condition-based Maintenance in Aerospace (Delft, Netherlands, 2022); 7) 25th Air Transport Research Society World Conference (Antwerp, Belgium, 2022); 8) 33rd Congress of the International Council of the Aeronautical Sciences (Stockholm, Sweden, 2022); 9) 10th World Congress "Aviation in XXI-st Century - Safety in aviation and space technology" (Kyiv, Ukraine, 2022); 10) IEEE 12th International Conference on Advanced Computer Information Technologies (Ruzomberok, Slovakia, 2022); 11) Ontario Aircraft Maintenance Conference; The Future of Aircraft Maintenance – Performance, Professionalism and Pride (Toronto, Canada, 2022). 12) International Workshop on Advances in Civil Aviation System Development (Kyiv, Ukraine, 2023).

"ПОГОДЖЕНО"

Проректор з навчальної роботи

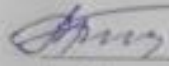
 « » _____ 2023 р.

Анатолій ПОЛУХІН

"ЗАТВЕРДЖУЮ"

Проректор з навчальної роботи
та інноваційного розвитку

 « » _____

Олександр СИДОРЕНКО



АКТ

про впровадження результатів дисертаційної роботи **Окоро Онїєдікачі Циома** на тему:
 «Оптимізація процесів технічного обслуговування для підтримання льотної придатності
 повітряних суден в Нігерії»
 в навчальний процес
 Національного авіаційного університету

Комісія у складі:

Голова комісії

Кулик М.С.

д.т.н., проф., декан АКФ

Члени:

Сидоренко О.Ю.

к.т.н., доц. заступник декана АКФ

Свирід М.М.

к.т.н., доц. заступник декана АКФ

Квач Ю.М.

к.т.н., доц. заступник декана АКФ

встановила, що результати дисертаційної роботи **Окоро Онїєдікачі Циома** за темою:
 «Оптимізація процесів технічного обслуговування для підтримання льотної придатності
 повітряних суден в Нігерії» впроваджені у навчальний процес кафедри підтримання льотної
 придатності повітряних суден АКФ:

- шляхом використання у курсі лекцій з дисципліни «Основи технічної діагностики»;
- впроваджено методика «Аналіз статистичних даних з надійності АТ» у
 кваліфікаційних роботах.

Голова комісії

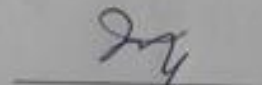

Микола КУЛИК

Члени комісії:



Олександр СИДОРЕНКО

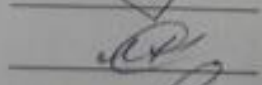

Михайло СВИРИД



Юлія КВАЧ